

Volume 2



Legacy: The 15 Volume
Encyclopedia

TABLE OF CONTENTS

(Mokcha)

TENETS OF TAEKWON-DO (<i>TAEKWON-DO JUNGSHIN</i>)	8
EXPLANATION OF TENETS	10
THEORY OF POWER (<i>Him Ui Wolli</i>)	14
ATTACKING AND BLOCKING TOOLS (<i>Kyong Gyok mit Makgi Boowi</i>)	49
Hand Parts (<i>Sang Bansin</i>)	53
Foot Parts (<i>Ha Bansin</i>)	76
Miscellaneous Parts (<i>Gita Boowi</i>)	82
VITAL SPOTS (<i>Kupso</i>)	88
Sections of the Body (<i>Mom Dungboon</i>)	90
Checklist (<i>Daejo Pyo</i>)	97
RELATION OF ATTACKING TOOLS AND VITAL SPOTS	100
STANCE (<i>Sogi</i>)	135
TRAINING (<i>Sooryon</i>)	169
TRAINING EQUIPMENT (<i>Sooryon Jangbi</i>) ..	174
Practice Suit (<i>Do Bok</i>)	176
Training Aids (<i>Dallyon Goo</i>)	186
Improvised Training Aids	284
CALISTHENICS (<i>Dosoo Dallyon</i>)	285
SYNOPSIS	294
INDEX	296



choi hong hi

GEN. CHOI HONG HI
President

International Taekwon-Do Federation

THE TENETS OF TAEKWON-DO

(Taekwon-Do Jungshin)

TAEKWON-DO AIMS TO ACHIEVE

Courtesy (*Ye Ui*)

Integrity (*Yom Chi*)

Perseverance (*In Nae*)

Self-Control (*Guk Gi*)

Indomitable Spirit (*Baekjul Boolgool*)

昭春道精神
禮義廉耻忍耐
老已百折不屈

蒼舒存滋想

EXPLANATION OF TENETS

Needless to say, the success or failure of Taekwon-Do training depends largely on how one observes and implements the tenets of Taekwon-Do which should serve as a guide for all serious students of the art.

COURTESY (*Ye Ui*)

Taekwon-Do students should attempt to practise the following elements of courtesy to build up their noble character and to conduct the training in an orderly manner as well.

- 1) To promote the spirit of mutual concessions
- 2) To be ashamed of one's vices, contempting those of others
- 3) To be polite to one another
- 4) To encourage the sense of justice and humanity
- 5) To distinguish instructor from student, senior from junior, and elder from younger
- 6) To behave oneself according to etiquette
- 7) To respect others' possessions
- 8) To handle matters with fairness and sincerity
- 9) To refrain from giving or accepting any gift when in doubt

INTEGRITY (*Yom Chi*)

In Taekwon-Do, the word integrity assumes a looser definition than the one usually presented in Webster's dictionary. One must be able to define right and wrong, and have the conscience, if wrong, to feel guilt. Listed are some examples, where integrity is lacking:

1. The instructor who misrepresents himself and his art by presenting improper techniques to his students because of a lack of knowledge or apathy.
2. The student who misrepresents himself by "fixing" breaking materials before demonstrations.
3. The instructor who camouflages bad techniques with luxurious training halls and false flattery to his students.
4. The student who requests rank from an instructor, or attempts to purchase it.
5. The student who gains rank for ego purposes or the feeling of power.
6. The instructor that teaches and promotes his art for materialistic gains.
7. The student whose actions do not live up the words.
8. The student who feels ashamed to seek opinions from his juniors.

PERSEVERANCE (*In Nae*)

There is an old Oriental saying, "Patience leads to virtue or merit" "One can make a peaceful home by being patient for 100 times." Certainly, happiness and prosperity are most likely brought to the patient person. To achieve something, whether it is a higher degree or the perfection of a technique, one must set his goal, then constantly persevere. Robert Bruce learned his lesson of perseverance from the persistent efforts of a lowly spider. It was this perseverance and tenacity that finally enabled him to free Scotland in the fourteenth century. One of the most important secrets in becoming a leader of Taekwon-Do is to overcome every difficulty by perseverance.

Confucious said; "one who is impatient in trivial matters can seldom achieve success in matters of great importance."

SELF-CONTROL (*Guk Gi*)

This tenet is extremely important inside and outside the do jang, whether conducting oneself in free sparring or in one's personal affairs. A loss of self-control in free sparring can prove disastrous to both student and opponent. An inability to live and work within one's capability or sphere is also a lack of self-control.

According to Lao-Tzu "the term of stronger is the person who wins over oneself rather than someone else."

INDOMITABLE SPIRIT (*Baekjul Boolgool*)

"Here lie 300, who did their duty," a simple epitaph for one of the greatest acts of courage known to mankind.

Although facing the superior forces of Xerxes, Leonidas and his 300 Spartans at Thermopylae showed the world the meaning of indomitable spirit. It is shown when a courageous person and his principles are pitted against overwhelming odds.

A serious student of Taekwon-Do will at all times be modest and honest. If confronted with injustice, he will deal with the belligerent without any fear or hesitation at all, with indomitable spirit, regardless of whosoever and however many the number may be.

Confucius declared, "it is an act of cowardice to fail to speak out against injustice."

As history has proven those who have pursued their dreams earnestly and strenuously with indomitable spirit have never failed to achieved their goals.



"Pursue one's own goal"

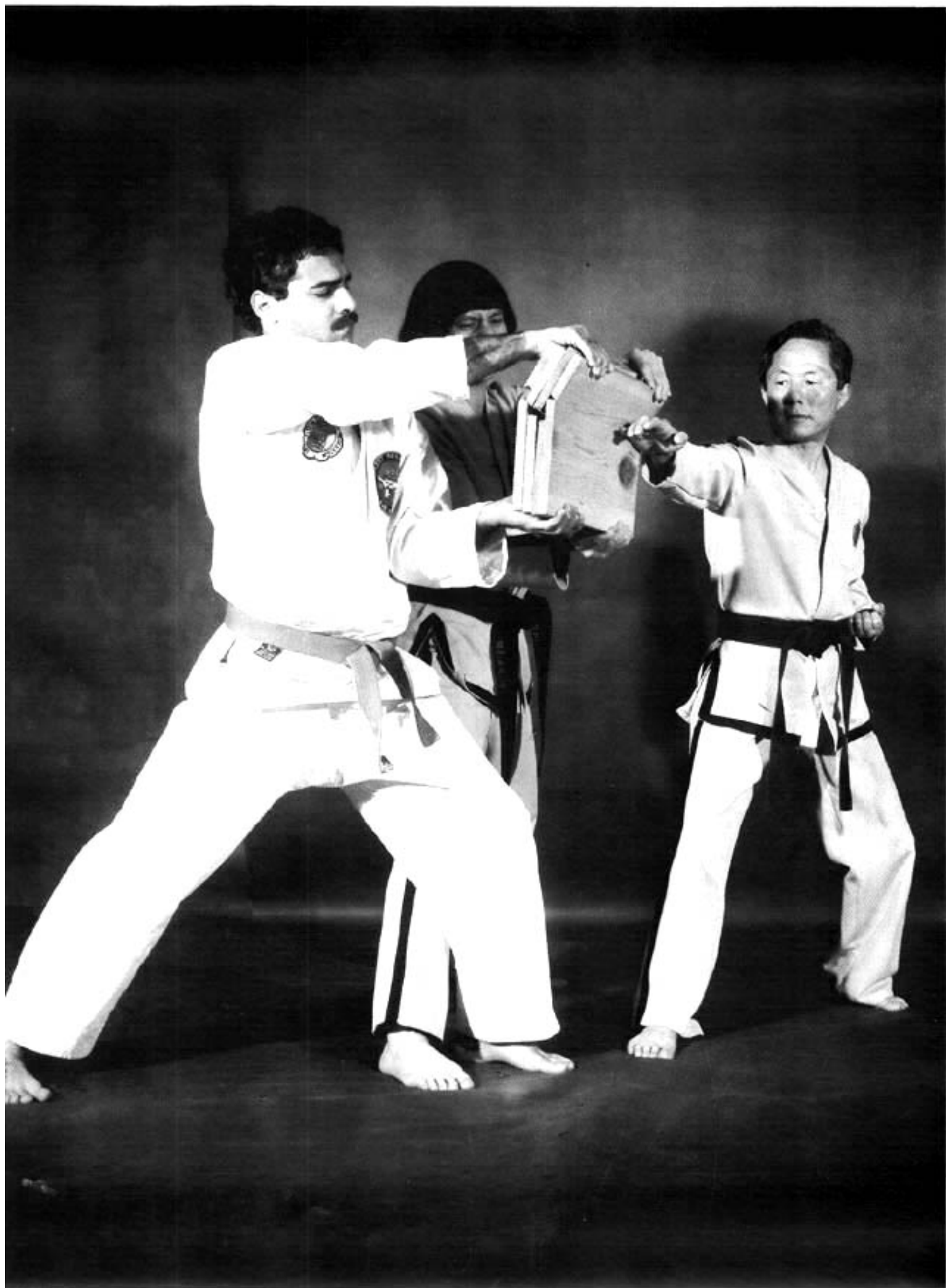

THEORY OF POWER

(Him Ui Wollli)

The beginning student may ask; "Where does one obtain the power to create the devastating results attributed to Taekwon-Do?" This power is attributed to the utilization of a person's full potential through the mathematical application of Taekwon-Do techniques. The average person uses only 10 to 20 percent of his potential. Anyone, regardless of size, age, or sex who can condition himself to use 100 percent of his potential can also perform the same destructive techniques.

Though training will certainly result in a superb level of physical fitness, it will not necessarily result in the acquisition of extraordinary stamina or superhuman strength. More important, Taekwon-Do training will result in obtaining a high level of reaction force, concentration, equilibrium, breath control and speed; these are the factors that will result in a high degree of physical power.



"Powerful enough to uproot mountains"

REACTION FORCE (*Bandong Ryok*)

According to Newton's Law, every force has an equal and opposite force. When an automobile crashes into a wall with the force of 2,000 pounds, the wall will return a force of 2,000 pounds; or forcing the end of a seesaw down with a ton of weight will provide an upward force of the same weight; if your opponent is rushing towards you at a high speed, by the slightest blow at his head, the force with which you strike his head would be that of his own onslaught plus that of your blow.

The two forces combined; his, which is large, and yours, which is small, are quite impressive. This, then, is the reaction force from the opponent. Another reaction force is your own. A punch with the right fist is aided by pulling back the left fist to the hip.



CORRECT



The maximum power is produced because the principle of reaction force is well observed, that is, the opposite fist is pulled to the hip at the moment of impact.

INCORRECT

Less power is produced because the principle of reaction force is ignored, that is, the left fist is not pulled to the hip.

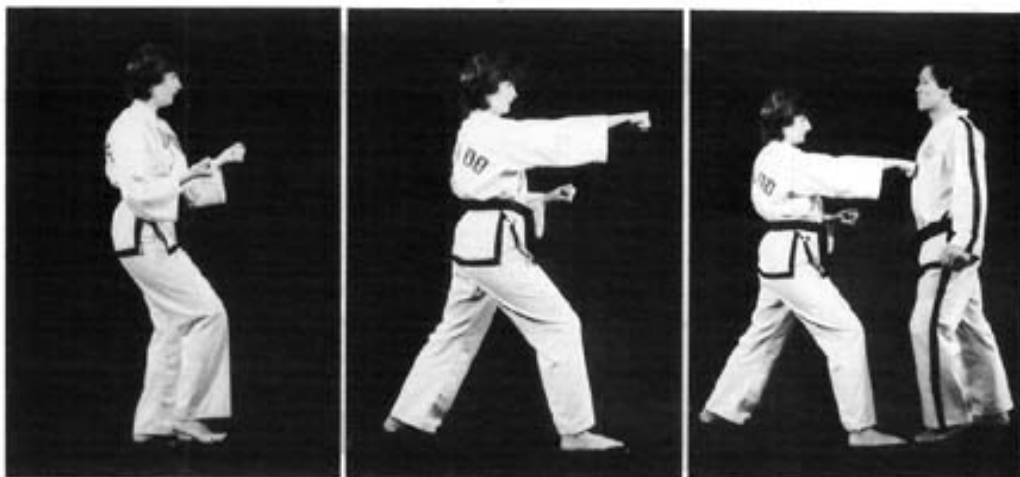

CORRECT



INCORRECT

The right fist fails to be pulled to the hip.

CORRECT

The right fist is pulled to the hip at the moment of the block.

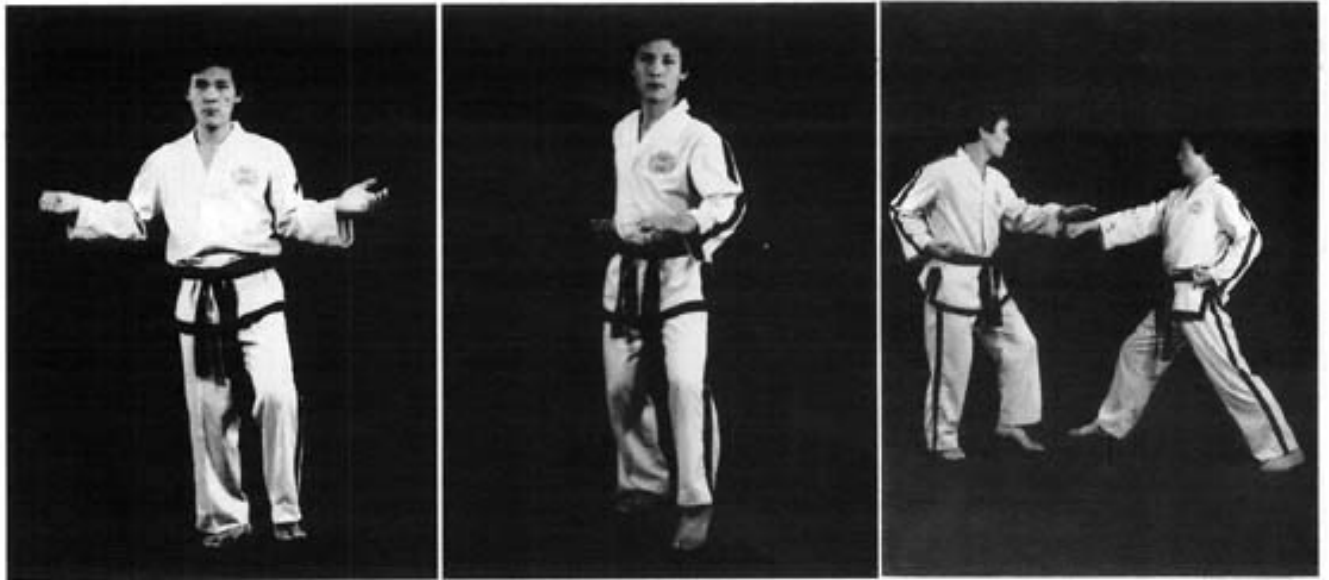

INCORRECT

The right fist is not pulled to the hip at the moment of the block.





CORRECT

The defender applies the principle of reaction force correctly by using the attacker's momentum and a minimum of his own power to throw his opponent off balance.



CORRECT

The punch is well executed for the same reason mentioned above.



CONCENTRATION (*Jip Joong*)

By applying the impact force onto the smallest target area, it will concentrate the force and therefore, increase its effect. For example, the force of water coming out of a water hose is greater if the orifice is smaller. Conversely, the weight of a man spread out on snow shoes makes hardly any impression on the snow. The blows in Taekwon-Do are often concentrated onto the edge of the open palm or to the crook of the fingers.

It is very important that you should not unleash all your strength at the beginning but gradually, and particularly at the point of contact with your opponent's body, the force must be so concentrated as to give a knock-out blow. That is to say, the shorter the time for the concentration, the greater will be the power of the blow. The utmost concentration is required in order to mobilize every muscle of the body onto the smallest target area simultaneously.

In conclusion, concentration is done in two ways: One is to concentrate every muscle of the body, particularly the bigger muscles around the hip and abdomen (which theoretically are slower than the smaller muscles of other parts of the body) towards the appropriate tool to be used at the proper time; the second way is to concentrate such mobilized muscles onto the opponent's vital spot. This is the reason why the hip and abdomen are jerked slightly before the hands and feet in any action, whether it be attack or defence.



Small outlet

Large outlet





CORRECT

Muscles are fully mobilized and well concentrated to the appropriate part of the forearm.

INCORRECT

The muscles of the hip and the abdomen are neither fully mobilized nor properly concentrated.



CORRECT

Muscles are fully mobilized because the hip rotates in the same direction as the hands.



INCORRECT

Muscles are not fully mobilized due to the failure to rotate the hip in the same direction as the hands.

CORRECT

Muscles are concentrated to the appropriate part of the foot - in this case to the footsword.

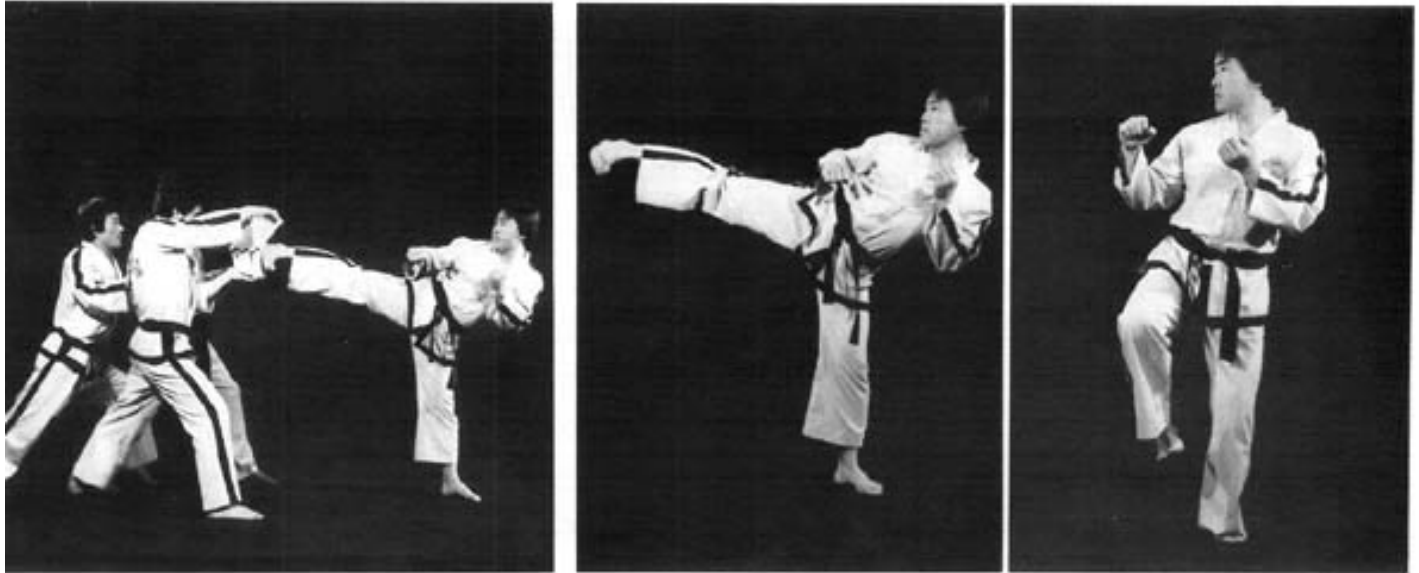

INCORRECT

Muscles are not dully concentrated to the appropriate part of the foot - in this case to the toe edge rather than the footsword.

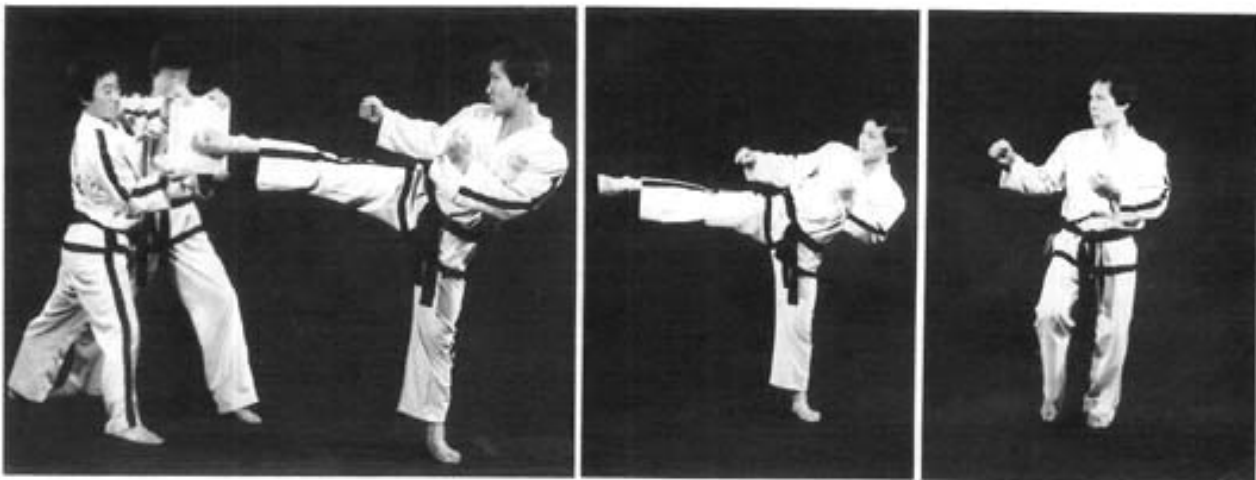

EQUILIBRIUM (*Kyun Hyung*)

Balance is of utmost importance in any type of athletics. In Taekwon-Do, it deserves special consideration. By keeping the body always in equilibrium, that is, well balanced, a blow is more effective and deadly. Conversely, the unbalanced one is easily toppled. The stance should always be stable yet flexible, for both offensive and defensive movements.

Equilibrium is classified into both dynamic and static stability. They are so closely inter-related that the maximum force can only be produced when the static stability is maintained through dynamic stability.

To maintain good equilibrium, the center of gravity of the stance must fall on a straight line midway between both legs when the body weight is distributed equally on both legs, or in the center of the foot if it is necessary to concentrate the bulk of body weight on one foot. The center of gravity can be adjusted according to body weight. Flexibility and knee spring are also important in maintaining balance for both a quick attack and instant recovery. One additional point; the heel of the rear foot should never be off the ground at the point of impact. This is not only necessary for good balance but also to produce maximum power at the point of impact.

Centre of gravity



CORRECT

Center of gravity



INCORRECT

Dynamic Stability (*Dongtchuk Anjong*)

Center of gravity



Moving Forward

Centre of gravity



INCORRECT



Balance is not maintained because the bulk of the body weight still remains at the centre of gravity instead of the left foot.



The same principle is applicable for moving backward.

Moving Sideways

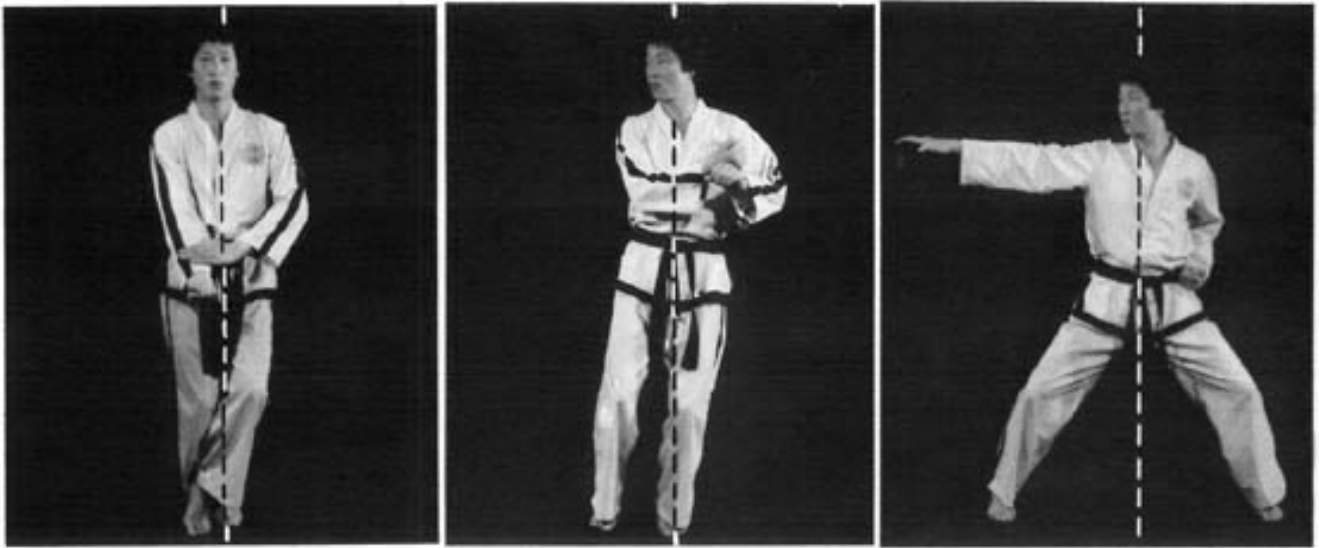

CORRECT

Center of gravity

Stance is too narrow.



INCORRECT
The bulk of the body weight fails to be concentrated on the left foot.



Stance is too wide.

Static Stability (*Jungchuk Anjong*)



CORRECT



INCORRECT

Right heel is off the ground.

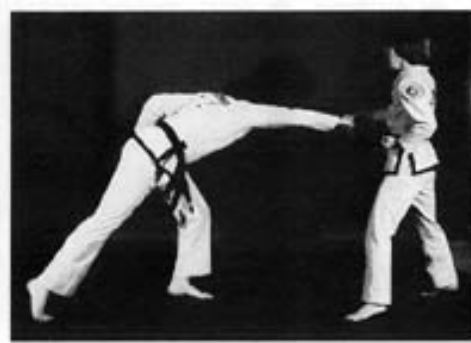

CORRECT



INCORRECT

Right knee is bent too much.



INCORRECT
Right knee is pointed outward
instead of inward.



CORRECT



INCORRECT
Heel of the stationary foot is off the
ground.



CORRECT



INCORRECT
The body is leaned forward.



INCORRECT
The body is leaned too far backward.



CORRECT



BREATH CONTROL (*Hohup Jojul*)

Controlled breathing not only affects one's stamina and speed but can also condition a body to receive a blow and augment the power of a blow directed against an opponent. Through practice, breath stopped in the state of exhaling at the critical moment when a blow is landed against a pressure point on the body can prevent a loss of consciousness and stifle pain. A sharp exhaling of breath at the moment of impact and stopping the breath during the execution of a movement tense the abdomen to concentrate maximum effort on the delivery of the motion, while a slow inhaling helps the preparation of the next movement. An important rule to remember: Never inhale while focusing a block or blow against an opponent. Not only will this impede movement but it will also result in a loss of power.

Students should also practice disguised breathing to conceal any outward signs of fatigue. An experienced fighter will certainly press an attack when he realizes his opponent is on the point of exhaustion.

One breath is required for one movement with the exception of a continuous motion.

CORRECT

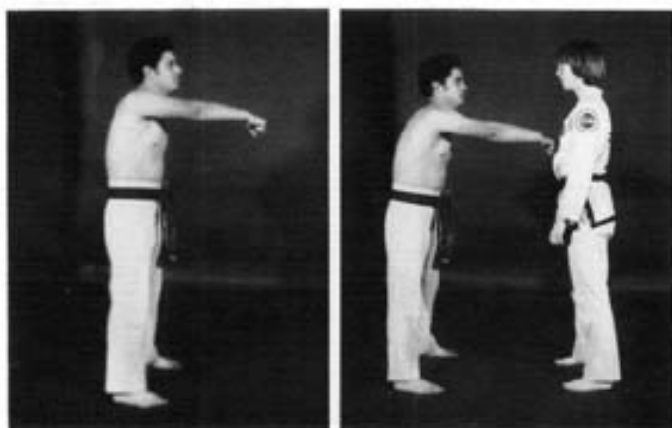
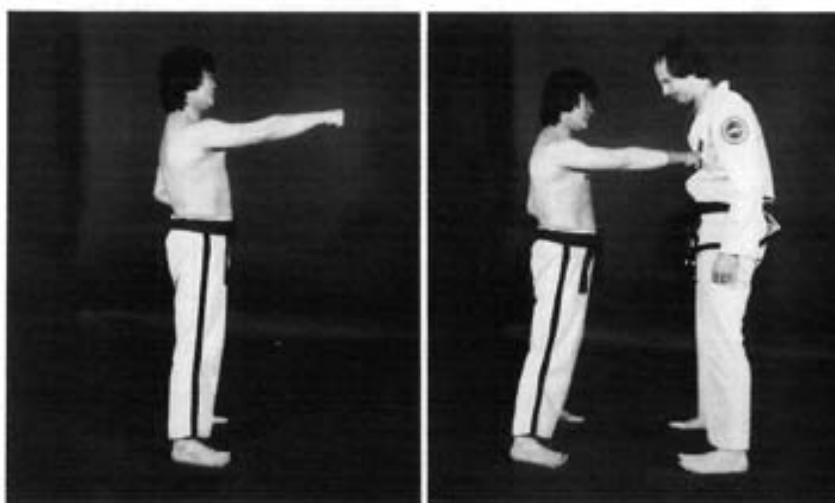

INCORRECT

Fist has been stopped before reaching the target because of inhaling at the moment of impact.

CORRECT



INCORRECT
Block is performed while inhaling rather than exhaling.



CORRECT



INCORRECT
For the same reason mentioned above.



MASS (*Zilyang*)

Mathematically, the maximum kinetic energy or force is obtained from maximum body weight and speed and it is all important that the body weight be increased during the execution of a blow. No doubt the maximum body weight is applied with the motion by turning the hip. The large abdominal muscles are twisted to provide additional body momentum. Thus the hip rotates in the same direction as that of the attacking or blocking tool as in figure F. Another way of increasing body weight is the utilization of a springing action of the knee joint. This is achieved by slightly raising the hip at the beginning of the motion and lowering the hip at the moment of impact to drop the body weight into the motion as in figure G.

In summarizing, it is necessary to point out that the principles of force outlined here hold just as true today in our modern scientific and nuclear age as they did centuries ago.

I am sure that when you go through this art, both in theory and in practice, you will find that the scientific basis of the motions and the real power which comes out a small human body cannot fail to impress you.

Fig. F

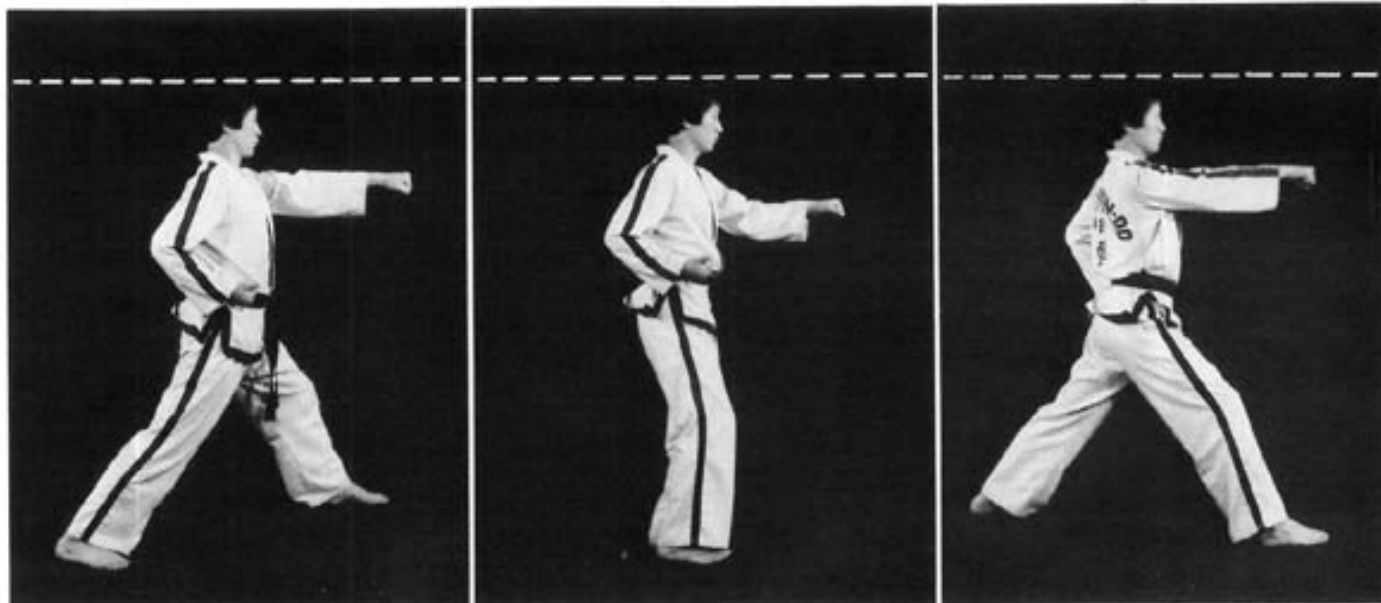

Fig. G



CORRECT

The hip raised.



The hip is lowered.

INCORRECT

The hip was kept at the same level throughout the movement, thus failing to increase the body weight.

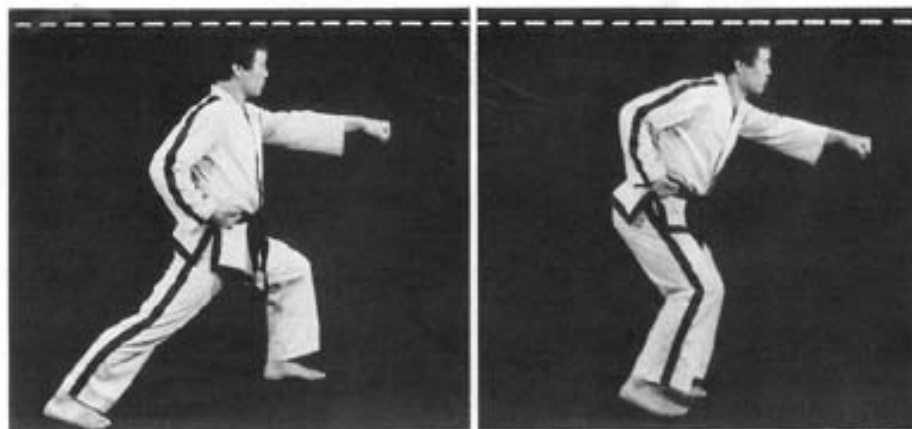



**As a result maximum
power is produced.**



The result is less power.



CORRECT

The hip rotates in the same direction as that of the attacking tool — in this case the left hand.



INCORRET

The body weight is not increased properly because the foot is moved in a saw tooth wave instead of a sine wave.



SPEED (*Sokdo*)

Speed is the most essential factor of force or power. Scientifically, force equals mass X acceleration ($F=MA$) or ($P=MV^2$).

In figure A, a large stone has been gently dropped on a double pane of glass from a height of three inches. On the other hand, in figure B, a small stone has been thrown against the glass with great speed. In figure C, the flat of the hand passed in a slow motion through the flame of the candle with no result to the flame. The candle, however, was put out with a controlled punch or kick stopping within an inch of the flame as shown in figures D and E.

According to the theory of kinetic energy, every object increases its weight as well as speed in a downward movement. This very principle is applied to this particular art of self-defence, as proved in pages 29 and 30. For this reason, at the moment of impact, the position of the hand normally becomes lower than the shoulder and the foot lower than the hip while the body is in the air.

Reaction force, breath control, equilibrium, concentration and relaxation of the muscles cannot be ignored. However, these are the factors that contribute to the speed and all these factors, together with flexible and rhythmic movements, must be well coordinated to produce the maximum power in Taekwon-Do.

Fig. A

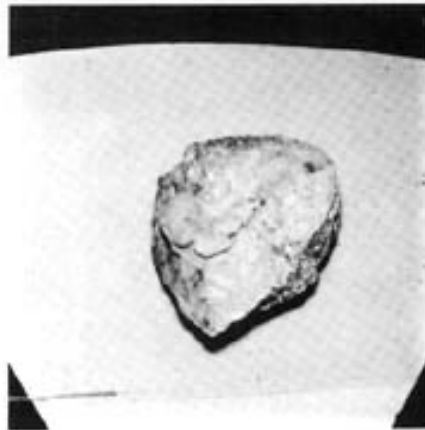

Fig.B

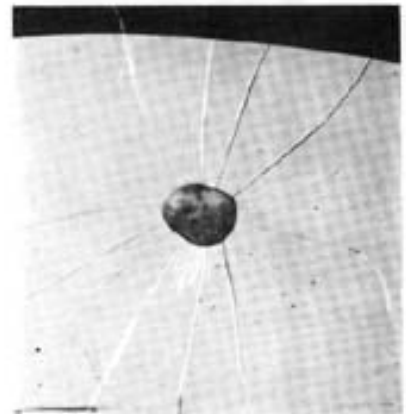

Fig. C

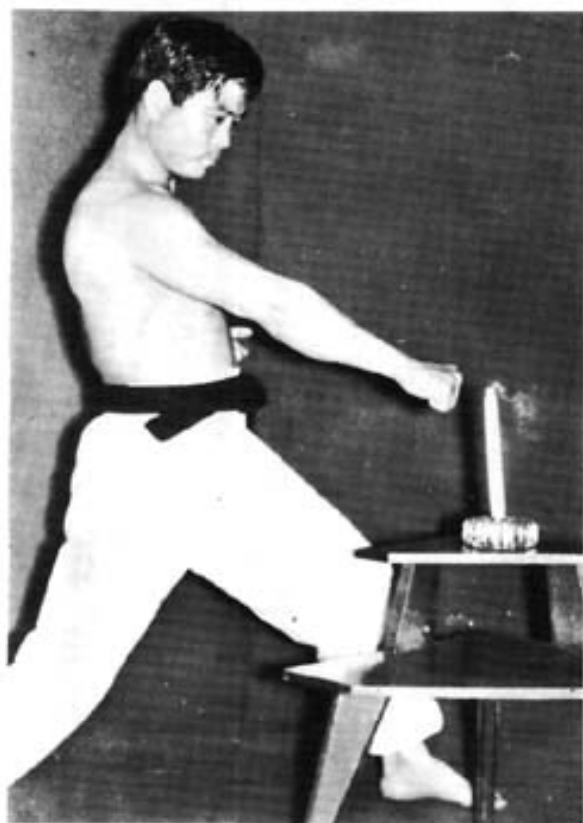

Fig. D

Fig. E





CORRECT



INCORRECT
Less power is produced because the point of focus is higher than the shoulder.



INCORRECT
Less power is produced as the hip is lower than the point of focus.

CORRECT



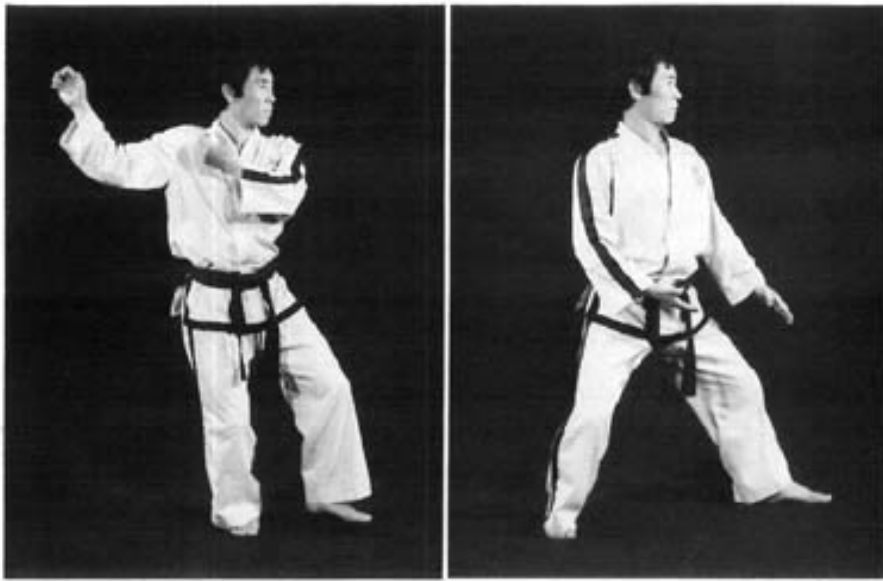

CORRECT



INCORRECT
Block is not as forceful as it should be.



SPEED AND REFLEX (*Sokdo wa Banung*)

It is essential for the students of Taekwon-Do to understand the relation of the speed and the execution time of techniques in order to apply them effectively.

Achieving precise measurements of these factors has been very difficult due to the great speed at which Taekwon-Do techniques are performed. However, in April of 1973, I conducted an experiment to measure the precise speed and execution time of various techniques.

The approach used was multi-flash Strobe photography. Two EG&G control units—model 553-11 (serial No. 248 and No. 256), and two flashes in reflectors were used to record movements on film. This experiment was conducted at the M.I.T. Strobe lab with special permission from Professors Edgerton and Miller.

Results of the experiment are presented below:



Side Piercing Kick

In this photograph, we can see three images of the right foot once it is lifted off the floor. Three images produce two intervals. The Strobe was set at 20 flashes per second, which means one interval is equal to $1/20$ (0,05) of a second.

We can see from the photograph that it takes two intervals to complete this kick, which means that it takes $1/10$ (0,1) of a second to execute.

Hooking Kick



In this photograph the right foot passes by my face after $3 \frac{1}{2}$ intervals. The flash frequency was 30 per second, so it takes 0,117 seconds or just a little more than $1/10$ of a second to execute this kick.

One remarkable fact is that the execution times of the above kicks are shorter than the normal reflex time, which means that it is impossible for anyone to block these kicks unless he can detect them before the leg is lifted off the floor; i.e., know what kick is coming before it is executed.

Normal reflex time is the elapsed time of reflex action. Reflex action consists of behavior in which the reactions usually occur as direct and immediate responses to particular stimuli. Here we are dealing with conditioned reflexes, which can be defined as built-up adjustments to particular external stimuli; i.e., seeing a punch or kick coming and responding by blocking or moving out of the path. Normal reflex time has been experimentally determined to be around $2/10$ of a second, at the quickest.

Flying Front Kick



In this photograph, one interval is equal to $1/10$ (0,1) of a second. Execution of a flying front kick takes one interval which means that this kick takes $1/10$ (0,1) of a second to be completed.



**This picture illustrates a defence
against a sword attack.**

Front Punch



The speed of a punch was also tested. Here we see one interval of 30 flashes per second. Therefore, it takes 0.03 or $\frac{3}{100}$ of a second for the punch to be completed.

All these techniques cannot be blocked if we wait until an opponent begins to execute them, since the execution times of these techniques are shorter than the time it takes for our reflexes to respond. Therefore, we must be able to detect the on-coming of these techniques before-hand. This is the reason why one must gaze at the opponent's eyes at all times and not at the legs or arms.

At this point, it would be advantageous to introduce a formula which will enable the student to further understand the significance of speed in the execution of Taekwon-Do techniques.

The formula we can use to calculate the power of any technique is:

$$P = 1/2 MV^2$$

P stands for power.

1/2 is a constant.

M stands for mass.

V stands for velocity or speed.

This equation clearly reveals why developing speed is the most important factor in developing power.

For example, if the mass is increased by a factor of three (with the speed kept constant) then the power is also increased by a factor of three. But if the speed is increased by a factor of three (with mass kept constant) then the power is increased by a factor of nine.

Hence, with this formula we can measure the power of each technique:

$$\begin{aligned} \text{Power} &= (1/2) \times (\text{mass}) \times (\text{velocity})^2 \\ &= (1/2) \times (\text{mass}) \times (\text{velocity}) \times (\text{velocity}) \end{aligned}$$

And speed (velocity) can be expressed as

$$V = (\text{distance of last interval}) \times (1/\text{execution time of last interval})$$

This experiment has been a simple demonstration of how fast and powerful Taekwon-Do techniques can be practiced properly as taught.

This experiment is contributed by Jae Hun Kim, 3rd degree black belt holder.



Taekwon-Do
In Korean Character

Taekwon-Do
In Chinese Character.





ATTACKING AND BLOCKING TOOLS (*Gong Gyok mit Makgi Boowi*)

As the claws of a tiger or the wings of a bird constitute weapons in their own ways, so do the hands and feet of man form natural weapons. One of the important features of Taekwon-Do training turns the hands and feet into tough effective weapons capable of withstanding the harshest test without being damaged or dulled.

Even the best wood cutter must give up tree cutting if his axe or saw is broken. In war time, even the sharpshooter becomes helpless and perhaps gets killed if his gun does not fire because of long neglect of cleaning.

By the same token even the master of Taekwon-Do who is well versed in the technique may succumb to an attacker if he or she breaks a hand or foot during combat because they were weak from lack of toughening or training manoeuvres. In addition to publicizing Taekwon-Do during normal dealings with others, the students are encouraged to actively participate in the demonstration programs in which the breaking of tiles and pine boards can serve as a testimony to the public of the power of Taekwon-Do.

In this manner, the students of Taekwon-Do can maintain the discipline of exercise to keep the hands and feet hardened and in constant readiness.

No matter how skilful one's techniques are, if the techniques lack force, one is unable to impart any pain or shock to the opponent during the actual combat.

The part or surface through which the shock or power is transmitted to the opponent's body is called the attacking tool and any part or surface which intercepts or repulses the attack is called the blocking tool.

Theoretically, all locations of the concentration of strength are considered as attacking tools, most of which serve also as blocking tools. The nineteen parts or positions where the strength can be easily concentrated and toughened or developed are the most frequently used tools in Taekwon-Do.

They are divided into hand parts, foot parts and miscellaneous parts.

Remember that unlike other tools, they cannot be obtained easily but can only be gained through ceaseless training under the anvil of firm individual resolution.



ATTACKING TOOLS (*Gong gyok boowi*)



"Only a single blow is sufficient for victory."

BLOCKING TOOLS (*Makgi Boowi*)



"Self confidence through intuitive awareness."



A. HAND PARTS (*Sang Bansin*)

The hand creates so many types of tools that special care should be paid to the selection of the appropriate tool for the appropriate target.

Forefist (*Ap Joomuk*)

The forefist is generally used for attacking the philtrum, ribs, solar plexus, chest, abdomen, jaw, etc.

The main knuckles of the forefinger and middle finger are the punching parts. The top and the front of the fist should form a right angle so the punching parts can be closely contacted with the target.

The wrist should not be bent when the fist is clenched. The forefist is occasionally used for a pressing block.



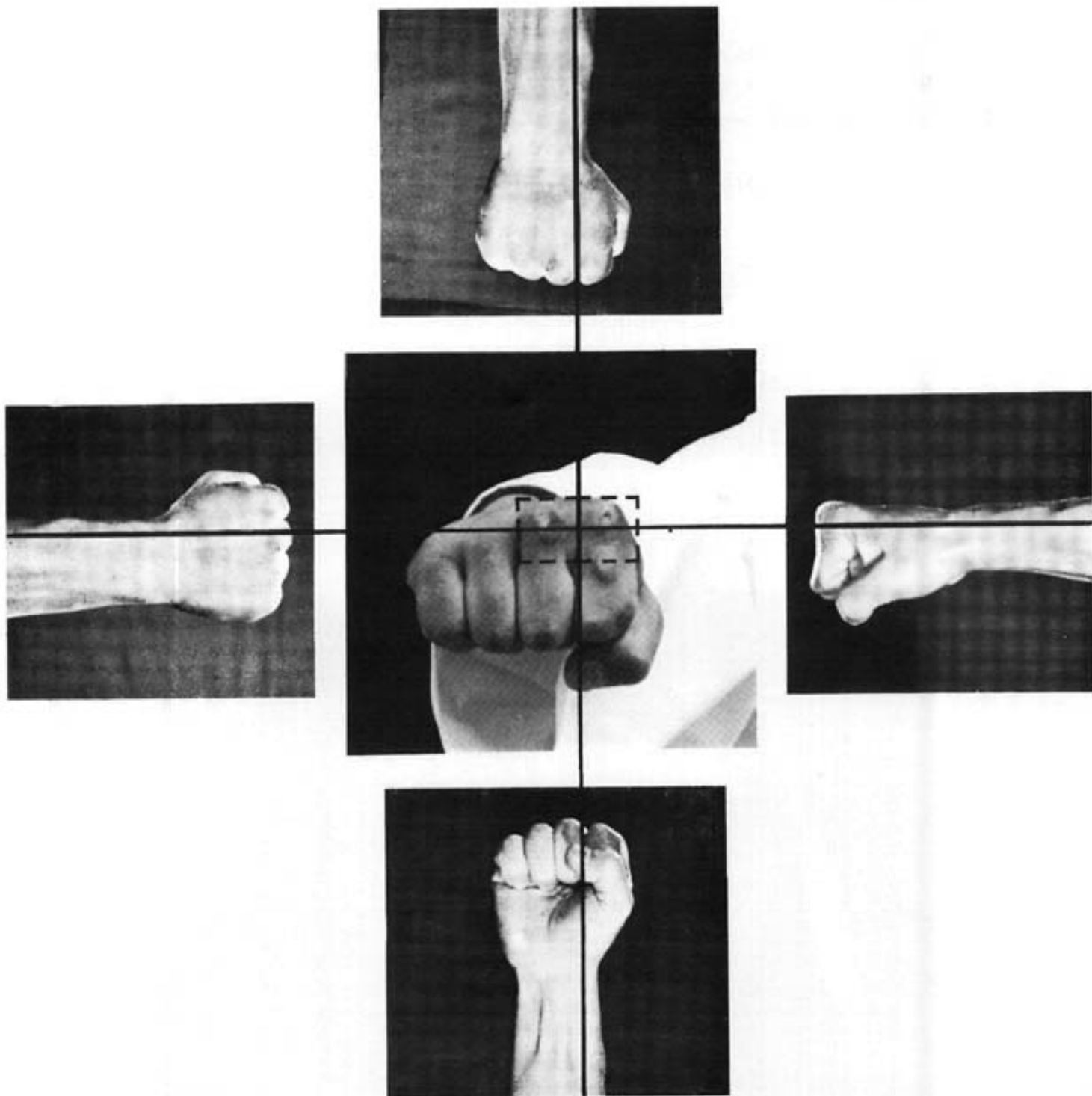

The lines show the center of power.



How to make a clenched fist (*Jwinun Bop*)

If the fist is not made firmly and correctly and if there is even the minutest of air space, the fist will be as weak as untempered steel and as soft as cotton. The fist must be tightly clenched at the moment of impact.



1. Open the hand naturally.



2. Roll the fingers tightly.



3. Press the fingers into the palm, starting with the little finger at the same time bending the thumb toward the inside.



4. Place the thumb on the forefinger and the middle finger pressing the forefinger properly.

Two incorrect methods of clenching a fist



1. The thumb is firmly placed on the middle finger. This method will weaken the side fist and place unnecessary strain on the shoulder and arm.



2. The thumb is placed on the extended forefinger. This method will weaken the forefinger joint and is somewhat unnatural, allowing air space within the fist.

The back of the hand normally faces upward at the moment of impact but occasionally it faces downward or outward.

The reasons for not bending the wrist are:

1. To prevent the wrist from being blocked or grabbed by the opponent.
2. To align the punching parts of the fist exactly on the target.
3. To concentrate maximum force on the punching parts.

For maximum power the front two knuckles must contact flush against the point of impact. Mathematically, power generated from the hip must flow in a smooth unbroken line through the forearm and out through the apex of the front two knuckles.

INCORRECT

No punching part has contacted with the target.

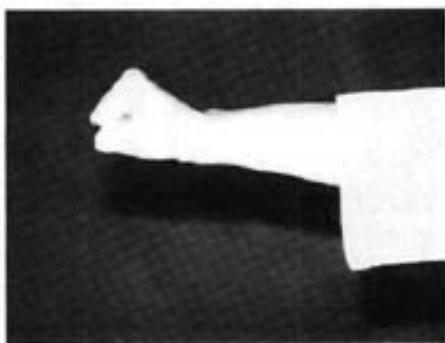

INCORRECT

Only a part of the main knuckle of the middle finger has contacted with the target.

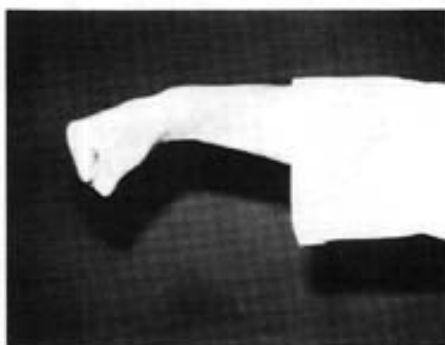
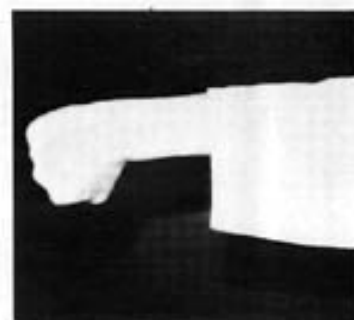

INCORRECT

Only a part of the main knuckle of the forefinger has contacted with the target.



INCORRECT

Only a part of the main knuckles of the forefinger and middle finger have contacted with the target.

CORRECT
The punching part is exactly aligned on target.

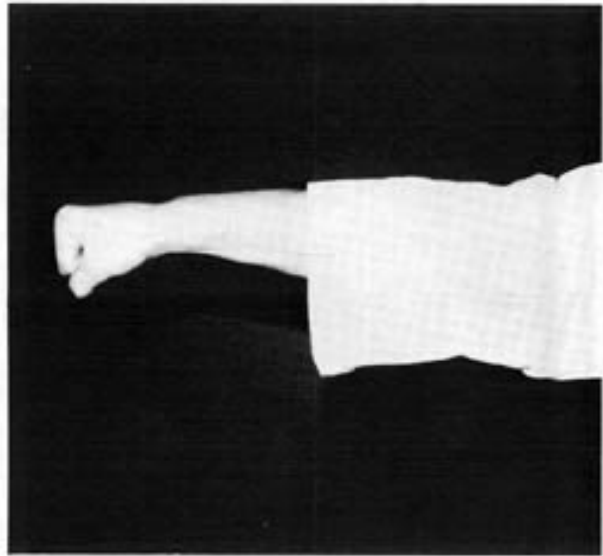

Correct punching part

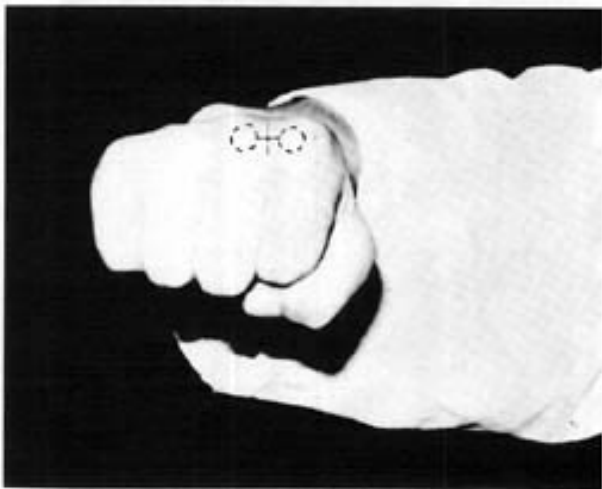

Incorrect punching part

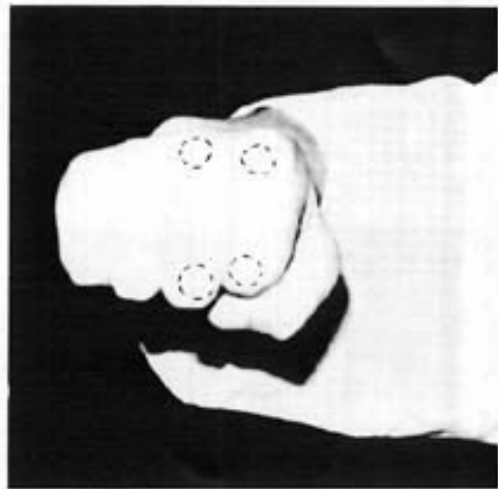

The line of power is moved to the center of the four knuckles instead of the two main knuckles.





Back Fist (*Dung Joomuk*)

This is primarily used for attacking the skull, forehead, temple, philtrum and abdomen, with the floating ribs and epigastrium secondary targets.

The main knuckles of the forefinger and middle finger are the parts used.



Side Fist (*Yop Joomuk*)

This is used for attacking the skull, elbow joint, ribs, solar plexus, philtrum and abdomen. It is occasionally used for blocking.

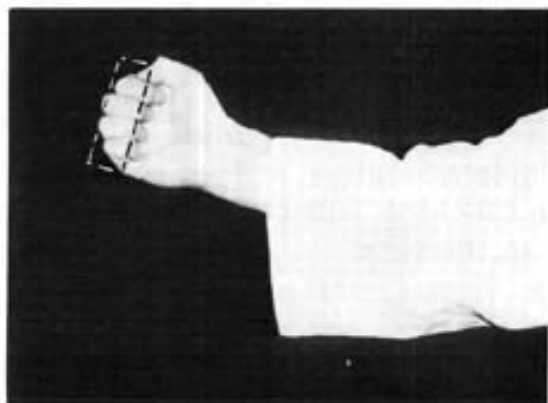
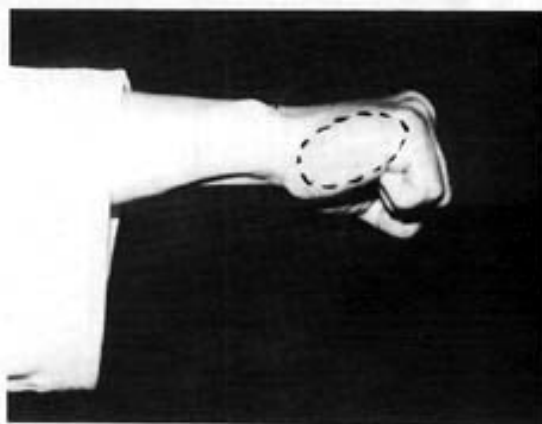

Under Fist (*Mit Joomuk*)

Roll the four fingers into the palm, pressing the forefinger slightly with the thumb. It is effective in attacking the jaw, lips, temple, solar plexus, Adam's apple and philtrum. The second knuckles of the forefinger, middle finger and ring finger comprise the attacking parts.

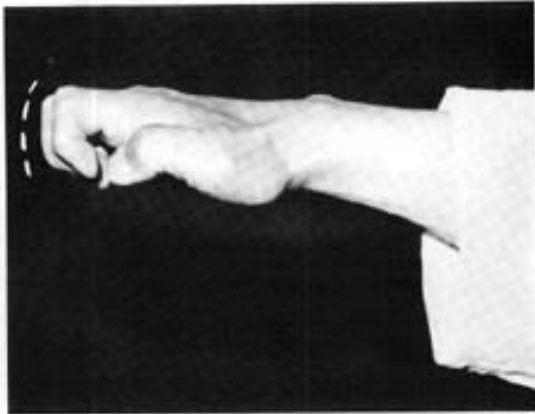

Long Fist (*Ghin Joomuk*)

This is very similar to an under fist except that the main knuckles are stiffened and the thumb is bent firmly, leaving some space between the forefinger and the thumb. It is used to attack the temple or the Adam's apple.

Open Fist (*Pyun Joomuk*)

It is created when the wrist is bent upward and all except the main knuckles are bent towards the palm. This is used to attack the nose, jaw and point of the chin.

It can be used in blocking in rare cases.

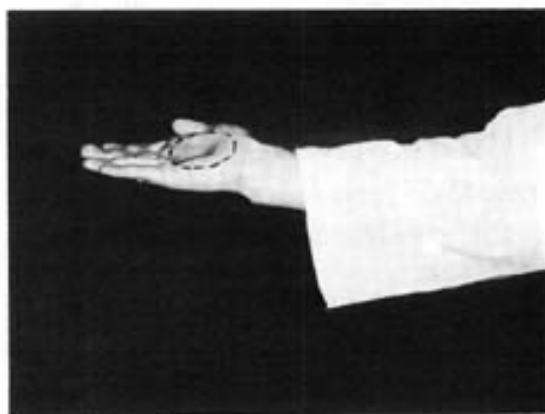
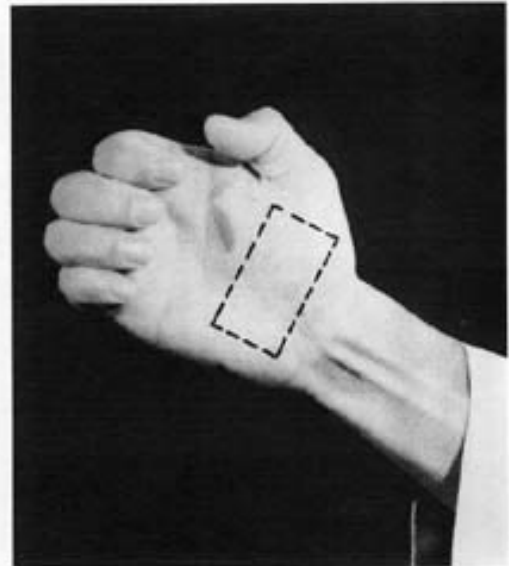

Palm (*Sonbadak*)

Bend all the fingers slightly toward the palm to strengthen it. This is chiefly used in blocking and occasionally for attacking the face.

Knuckle Fist (*Sonkarak Joomuk*)

This is formed with either one of the secondary knuckles of the forefinger or middle finger. The attack is more effective to a minute vital spot at a close distance if the snap motion is used properly.

Middle Knuckle Fist (*Joongji Joomuk*)

Push the secondary knuckle of the middle finger out of the forefist with the side of the thumb. It is used in attacking the solar plexus, temple and philtrum.

The solar plexus is attacked in the same way as an uppercut.



Fore-Knuckle Fist (*Inji Joomuk*)

Push the secondary knuckle of the forefinger out of an under fist with the thumb. It is used to attack the Adam's apple, temple and philtrum.

Thumb Knuckle Fist (*Umji Joomuk*)

The form is very similar to fore-knuckle fist but the fore-knuckle is not pushed out. It is used to attack the point of the chin, philtrum, temple and solar plexus.



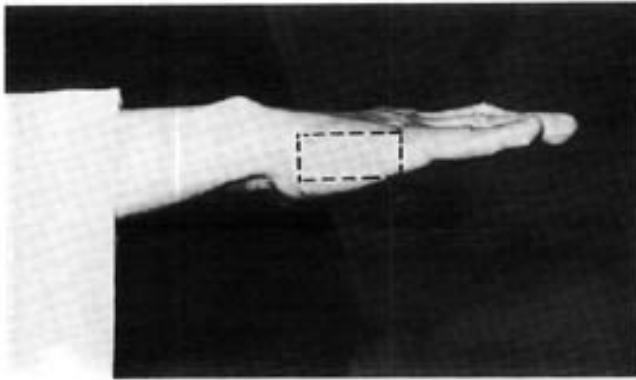

Knife-Hand (*Sonkal*)

This is a very powerful attacking tool, especially against a side target, and is used for attacking the skull, neck artery, bridge of the nose, temple, philtrum, clavicle, shoulder and floating ribs.

The knife-hand is also frequently used for blocking.

HOW TO MAKE A PROPER KNIFE-HAND

Press four fingers together bending the middle finger and ring finger slightly inward leaving some space between the forefinger and thumb, so that most of the strength is concentrated on the striking part, the surface from the wrist to the main knuckle of the little finger.



INCORRECT

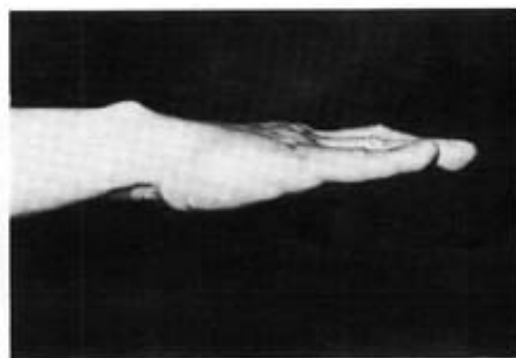

An incorrect way of forming a knife-hand is by pressing the thumb against the forefinger. This will weaken both the knife-hand and fingertips. In both cases, the joint of the little finger should not be used by beginners due to its weakness.





Reverse Knife-Hand (*Sonkal Dung*)

It is similar to the knife-hand except that the thumb is bent sharply toward the palm. It is used for attacking the neck, point of the chin, temple, philtrum, ribs and angle of the mandible. It is frequently used for blocking as well.

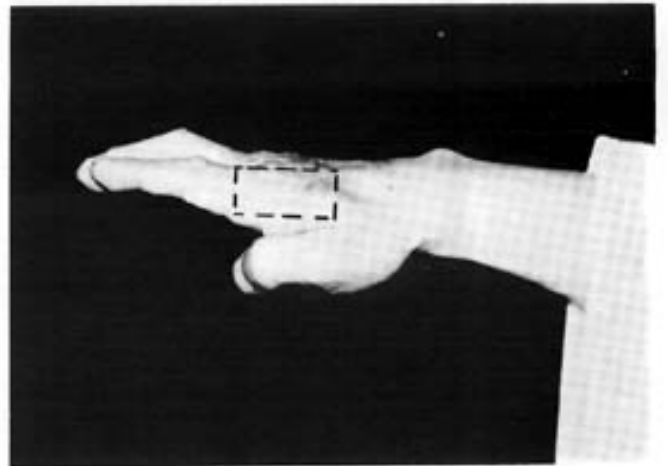

Fingertips (*Sonkut*)

This is a special tool found only in Taekwon-Do. The usage of it varies according to the target. The form of the hand is just the same as that of a knife-hand as far as straight, flat and upset fingertips are concerned. The fingertips are the parts used and a great emphasis is placed on evenly aligning the three fingertips—forefinger, middle finger and ring finger.

Flat Fingertip (*Opun Sonkut*)

The palm is faced downward at the moment of impact. It is chiefly used for attacking the ribs, eyes and occasionally the abdomen.

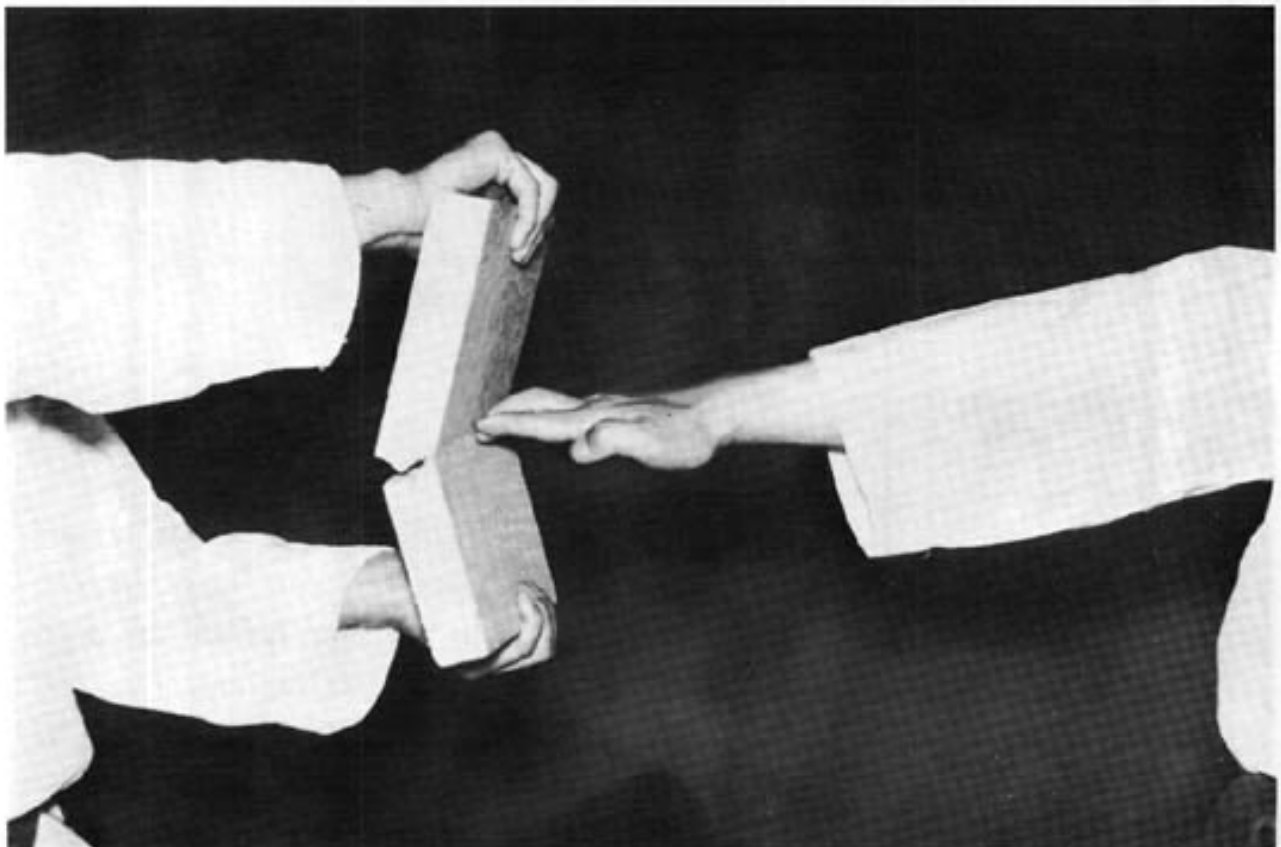

Straight Fingertip (*Sun Sonkut*)

The palm faces inward at the moment of impact. It is used for thrusting to either the solar plexus or the abdomen.



Upset Fingertip (*Dwijibun Sonkut*)

The palm faces upward at the moment of impact. It is mainly used for attacking the pubic region floating ribs and lower abdomen, though occasionally the armpit.

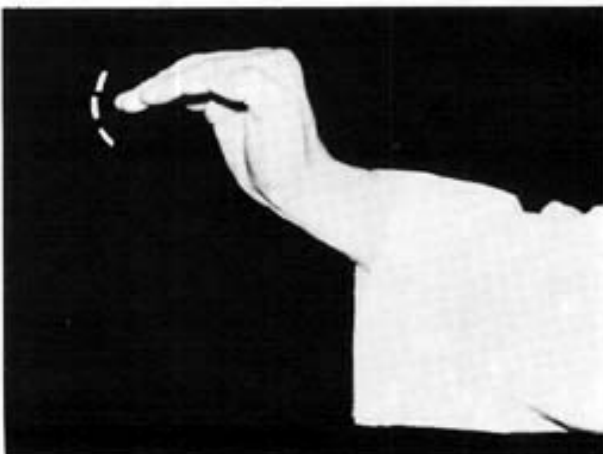

Angle Fingertip (*Homi Sonkut*)

Bend the main knuckle sharply pressing the secondary knuckle of the forefinger with the thumb until the angle becomes about 90 degrees.

It is especially useful in attacking the eyes or solar plexus from the right angle.



Thumb (*Umji*)

Extend the thumb out of the forefist. Be sure not to bend any joint of the thumb. It is used to thrust the solar plexus, ribs, eyes, windpipe and armpit.



Forefinger (*Han Sonkarak*)

The forefinger is extended, bending slightly while the others are clenched, the thumb pressing the middle finger.

It is mainly used in attacking the eyes, windpipe and mastoid.

Double Fingertip (*Doo Sonkarak*)

Forefinger and middle finger are extended, bending slightly while the others are clenched. Press the ring finger with the thumb. This tool can only be utilized against the eyes.

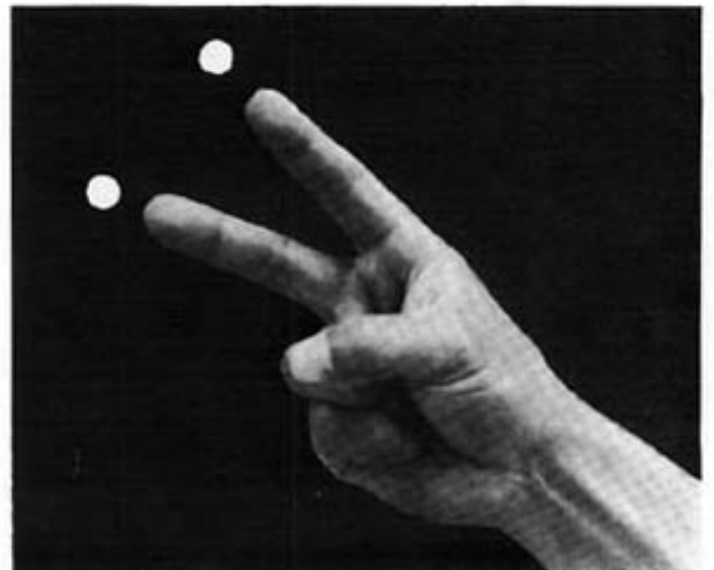
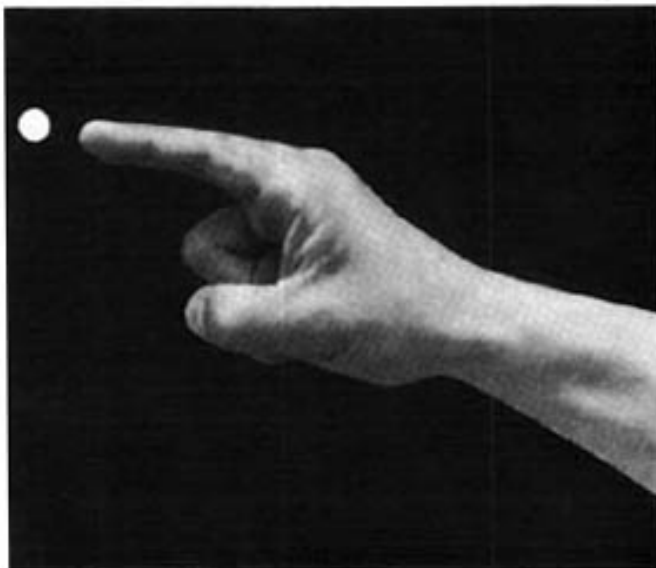



Arc-Hand (*Bandal Son*)

Bend three fingers slightly deeper than the forefinger while the thumb is bent toward the little finger. It is used to attack the Adam's apple, point of the chin and upper neck.

The surface between the secondary knuckle of the forefinger and thumb is used. The arc-hand is occasionally employed for blocking.

INCORRECT

Three fingers are clenched. This method is not practical since the forefinger is not supported by the three fingers which also become an obstacle when attacking the upper neck.

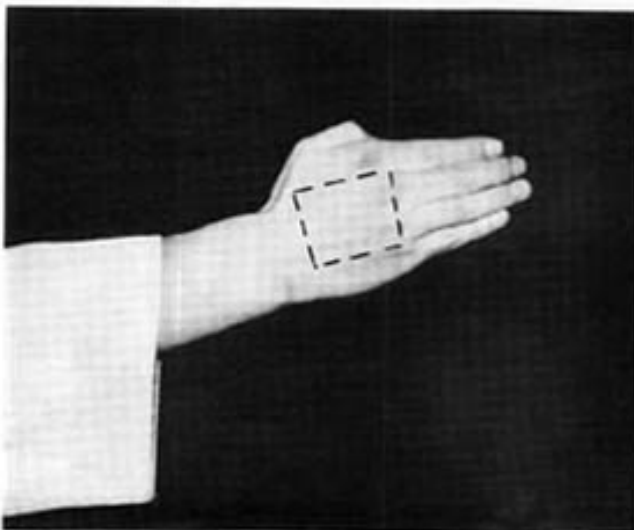

Back Hand (*Sondung*)

It is an ordinary open hand but by pressing the thumb against the side of the forefinger, it is used for attacking the face, jaw, lips and epigastrium. Occasionally the back hand is used for blocking.

Forearm (*Palmok*)

This is used for blocking and is classified into outer, inner, back and under forearm.

One-third of the arm, from the wrist to the elbow, is used.

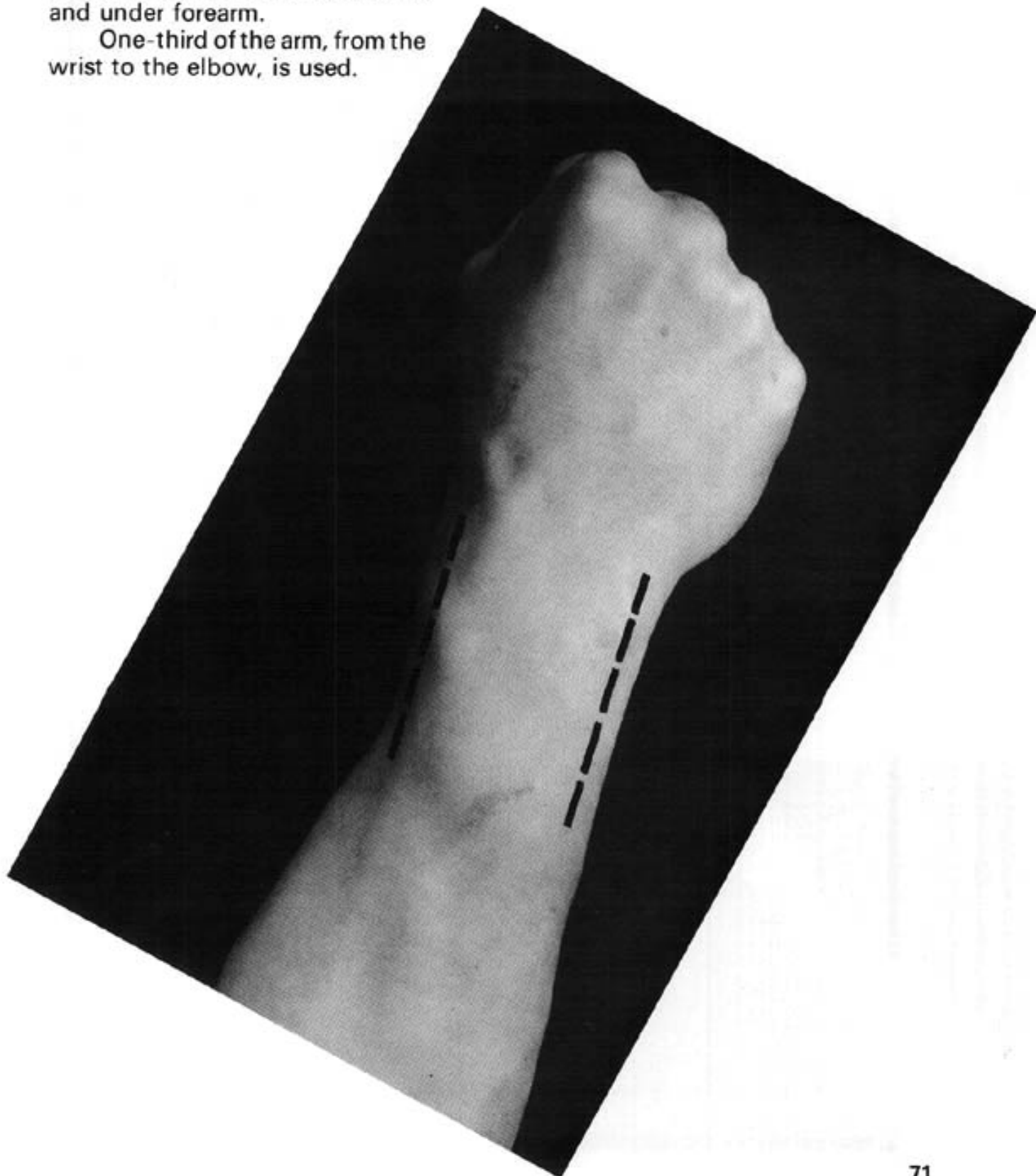

Outer forearm (*Bakatpalmok*)

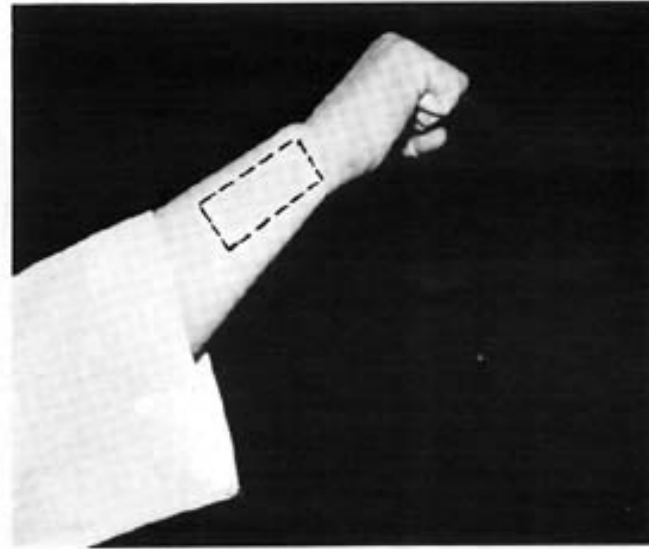

Back forearm
(*Dungpalmok*)



Inner forearm (*Anpalmok*)



Under forearm (*Mitpalmok*)

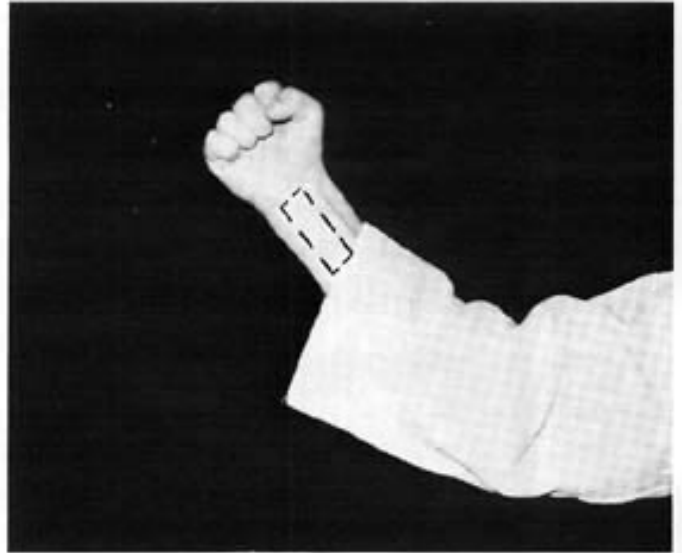

Elbow (*Palkup*)

The elbow is created when the arm is bent sharply. It is used for attacking the solar plexus, chest, abdomen, point of the chin, ribs, jaw, cervix, small of the back, etc.

It is classified into front, side, straight, high, upper and back elbow; frequently, the straight elbow serves as a blocking tool.



Finger Pincers (*Jipge Son*)

Three fingers are clenched while the thumb and forefinger are stretched out to form the shape of pincers. It is chiefly used to attack the Adam's apple and throat.

The secondary knuckle of the middle finger is used, together with the tips of the thumb and forefinger.

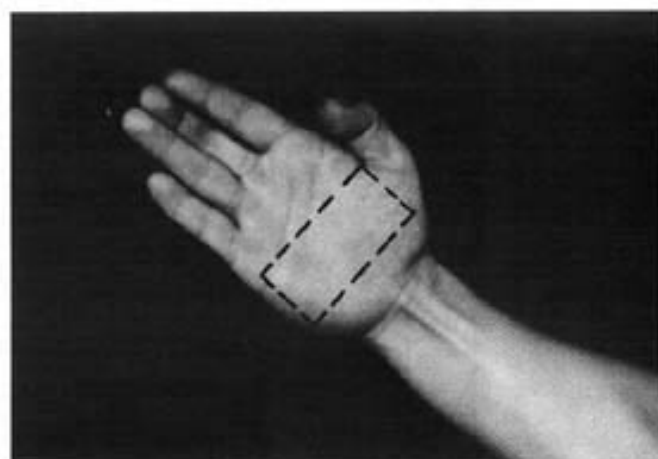

Press Finger (*Jiap*)

It is used to apply pressure to arteries and minute vital spots.



Base of Knife-Hand

(Sonkal Batang)

It is created when the wrist is bent sharply toward the thumb and is used to attack the clavicle only.



Bear Hand (*Gomson*)

Bend all fingers inward firmly. It is normally used in attacking the post auricular and jaw; occasionally the solar plexus and epigastrium.

Bow Wrist (*Sonmok Dung*)

This form is created when the wrist is bent downward. It is used in blocking.

Do not allow the wrist to bend too sharply.

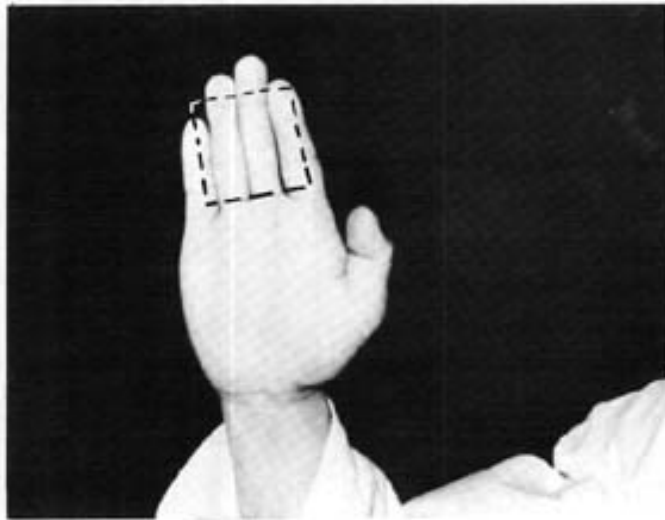
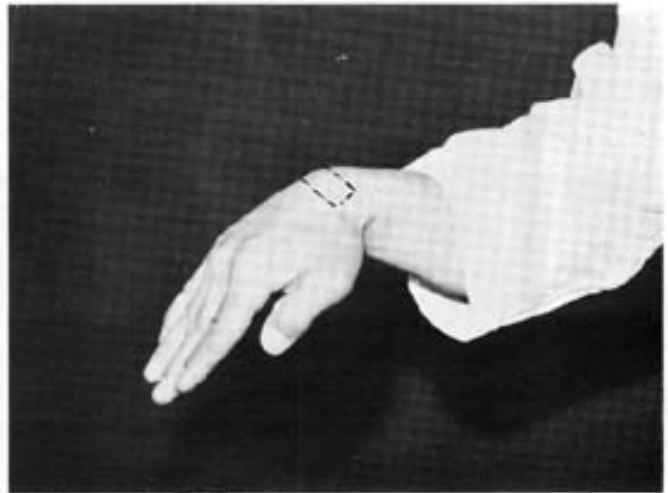

Finger Belly (*Songarak Badak*)

This is used only to adjust the back fist when attacking the philtrum by bringing it to the side fist at the moment of impact.

Thumb Ridge (*Umji Batang*)

The formation is similar to an arc-hand but the thumb is deeply bent downward and it is used in blocking.

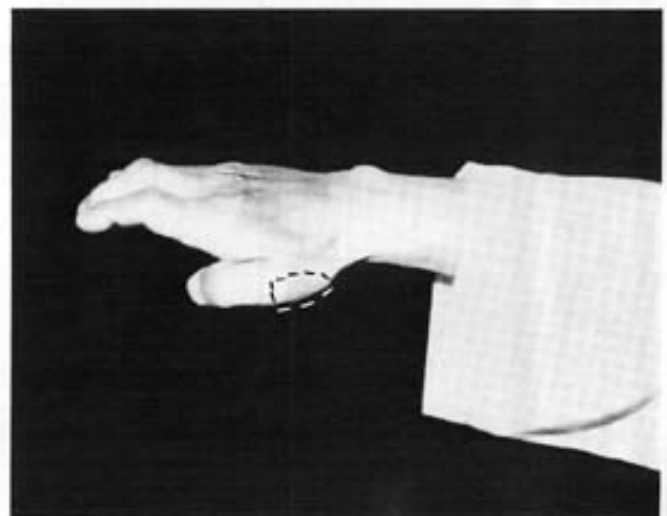

B. FOOT PARTS (*Ha Bansin*)

Most of the esoteric techniques of Taekwon-Do involve the feet which produce twice the amount of force of the hand motions.

Proper and timely employment of this tool cannot be overemphasized.



Ball of the Foot (*Apkumchi*)

The toes are bent sharply upward at the moment of impact. It is used to attack the face, point of the chin, inner thigh, chest, solar plexus, floating ribs, scrotum, coccyx and lower abdomen, and occasionally is used for blocking in support of the back sole.

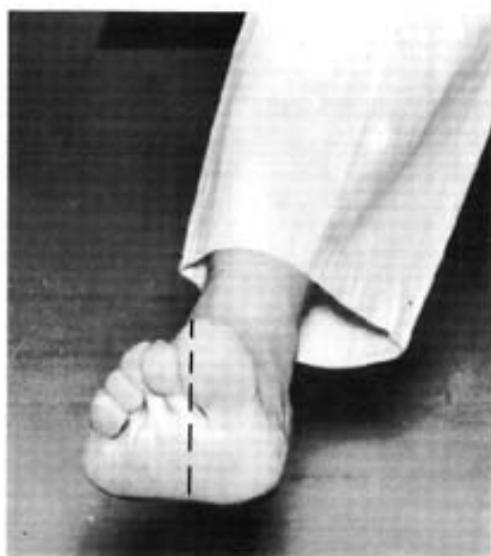

Front View



Footsword (*Balkal*)

This is considered the most important tool of the foot and is used to attack the philtrum, bridge of the nose, neck, solar plexus, chin, temple, armpit, floating ribs, knee joint, ankle joint and instep.

Frequently it is used for blocking. One-third of the edge, from the heel to the joint of the little toe, is the part used.

Remember to push out the heel while bending the root of the toes back to properly tense the footsword at the moment of impact.





Front View



Back Sole (*Dwitkumchi*)

It is primarily used for stamping and occasionally used for blocking in support of the ball of the foot. More targets naturally present themselves when used against a fallen opponent. This tool is extremely effective if shoes are worn.



Knee (*Moorup*)

It is an effective tool in attacking the solar plexus, abdomen, lower abdomen, face, chest and scrotum at a close distance.

Back View



Back Heel (*Dwichook*):

It is very widely used for attacking the philtrum, temple, solar plexus, scrotum, jaw and floating ribs.



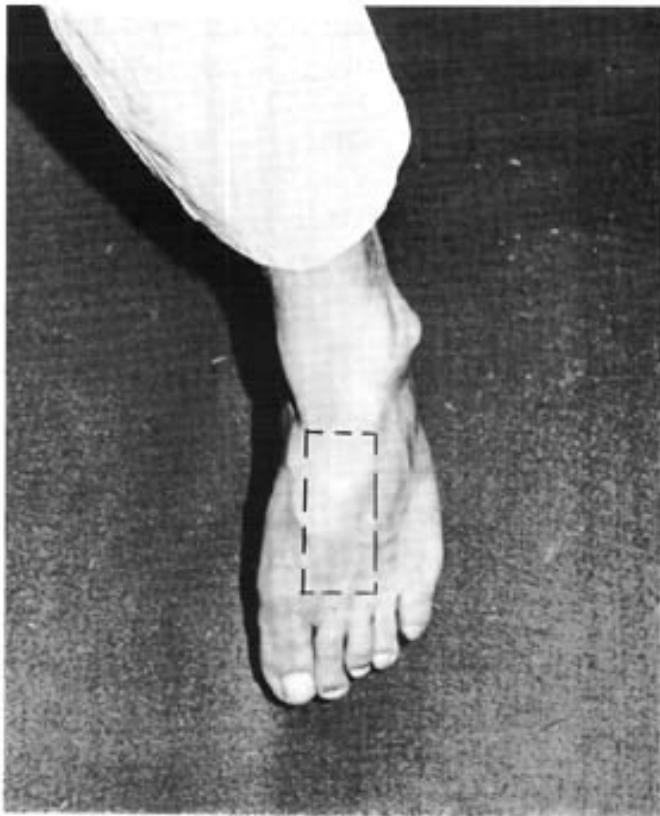

Instep (*Baldung*)

It is created when both the ankle and toes are bent sharply downward and is exclusively used in attacking the scrotum or jaw. However, the face, solar plexus, floating ribs and abdomen often become good targets, especially if shoes are worn.

Side Instep (*Yop Baldung*)

This form is created when the ankle is properly bent upward while twisting the foot until the instep faces almost downward. It is used for blocking.



Front View



Reverse Footsword (*Balkal Dung*)

This form is created when both the ankle and the toes are bent sharply upward. It is used for attacking the face, chest and solar plexus from a 90 degree angle.

Side Sole (*Yop Bal Badak*)

This form is created when the toes are properly bent upward while bending the ankle slightly upward. It is used in blocking.



Toes (*Balkut*)

It is used to attack the scrotum or abdomen. However, the floating ribs, point of the chin, solar plexus and other parts of the face can serve as targets when shoes are worn.

C. MISCELLANEOUS PARTS (*Gita Boowi*)

Some of the attacking and blocking tools listed here are not used unless absolutely necessary. They are not only difficult to toughen or harden but lower results can be expected when compared to the risk involved. It is, however, worthwhile to be prepared for any contingency.



forehead (ima)

Head (*Mori*)

It is classified into forehead and occiput: The former is quite effective in attacking the face or chest; the latter with the mouth open may be used for attacking the face when being grasped from behind. However, it is better not to use the occiput for obvious reasons. Other techniques may suffice.



Shoulder (*Euhke*)

It can be used for pushing away an opponent at a close distance.

Outer Ankle Joint (*Bakat Balmok Gwanjol*)



Occiput
(hudoo)

Inner Ankle Joint (*An Balmok Gwanjol*)



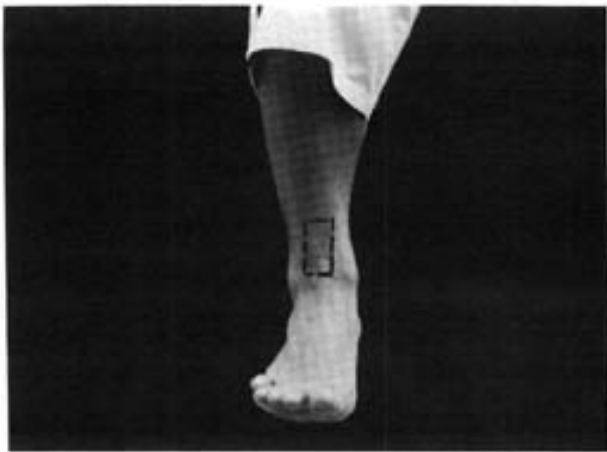

Tibia (*Kyong Gol*)



Inner Tibia (*An Kyong Gol*)



Outer Tibia (*Bakat Kyong Gol*)

Back Tibia (*Dwit Kyong Gol*)



Toe Edge (*Balgarak Nal*)

Shin (*Jong Kwaeng-i*)





THE CHEST (*Gasum*)

The chest is composed of the chest wall, lungs, heart, aorta and vena cava (the big vessels which take blood to and from the heart). The chest wall is composed of the ribs and muscles. These give excellent protection to the internal organs they surround. Consequently, the lungs, the heart or the blood vessels are only rarely injured in Taekwon-Do. It should be noted that the thoracic spine running through the middle of the back of the chest is very vulnerable to direct blows.

A blow to the breast of a woman will cause excruciating pain but serious damage is most unusual.

THE ABDOMEN (*Bokboo*)

The abdomen is a cavity containing many organs. It is formed by the diaphragm above and the pelvic diaphragm below. It is surrounded by the abdominal wall in front and on the sides. The back of the abdomen is formed by the lumbar spine and the paraspinal muscles. It should be realized that the lumbar spine, which is composed of 5 vertebrae, is the only solid support the abdomen has. Injury to the spine will result in leg pain or paralysis of the legs. Injury to the paraspinal muscles will cause back pain which may be disabling for many months or years. Solid organs of the abdomen are the liver, spleen, pancreas and kidneys. A direct blow to these may result in their rupture and life-threatening bleeding. The stomach and the intestines are never injured except with knife or gunshot wounds. A blow to the solar plexus is very disabling momentarily but with no long term consequences. In women, blows to the external genitalia are very painful but without serious sequela. In men, the situation is quite different. A blow to the genitalia can cause bleeding inside the testicles and subsequent inability to have children. It is evident that very serious consequences may accompany such a blow.

THE EXTREMITIES (*Pal Gwa Dari*)

The arms are joined to the rest of the body by the clavicle and the shoulder blades. Injury to these is not usually serious. The shoulder can be

easily dislocated and cause compression of the nerves and vessels that pass to the arm through the axilla (armpit). Note that the axilla is not protected whenever the arm is lifted. On the innerside of the elbow passes the ulner nerve. It is very vulnerable to injury at this point. Fractures of the wrist or hand may not appear serious but may cause severe long term disability. The knees are very vulnerable to an attack from the side. Note that once a broken knee, forever a weak knee. Tibias (shins) and feet are easily injured; however, disability is temporary.

All students should understand basic first aid including artificial respiration so it can be administered if needed. In the case of an internal injury, it is important to lay the injured party down quietly and check the party's complexion, state of consciousness, pulse and respiration. Do not move the body in any way and call a doctor immediately.

NEVER MAKE THE PATIENT WALK OR JUMP. IT MAY AGGRAVATE ANY INTERNAL HEMORRAGE.

VITAL SPOTS (*Kupso*)

Vital spot in Taekwon-Do is defined as any sensitive or breakable area on the body vulnerable to an attack. It is essential that a student of Taekwon-Do has a knowledge of the different spots so that he can use the proper attacking or blocking tool. Indiscriminate attack is to be condemned as it is inefficient and wasteful of energy.

The student should realize that in order to cause a significant injury different force may be necessary at different vital spots. For example, small force will cause a great damage if it is applied to the neck. On the other hand, the front of the abdomen, if appropriately strengthened, can withstand large force without significant injury to the internal organs.

Vital spots can be divided into two groups.

Major: Injury to these can lead to death or permanent disability.

Minor: Injury to these is not life threatening but will cause pain and temporary disability.

For the sake of simplicity, the human body can be divided into five groups: the head, chest, abdomen, external genitalia, and the four extremities.

THE HEAD (*Mori*)

The bone structure of the head is composed of the skull which protects the contents of the head. The skull itself is composed of 28 bones, eight of which protect and house the brain. The eyes are set deep in their sockets and thus they are well protected against hand or foot blows, except when attacked by fingers or toes, both of which can cause very serious damage indeed. The nose is composed of a bony part (the bridge of the nose) and the cartilage (the tip of the nose). A blow to the nose can result in fracture (break) and/or troublesome bleeding. Neither of these is usually serious. The mouth is formed by the maxilla into which are set the upper teeth, and the mandible (the jaw) into which are set the lower teeth. The floor of the mouth is filled by the tongue. The lips form the outside covering of the teeth. The upper lip has a groove in the midline called the philtrum (it is of no significance, except as a guiding point). Injuries to the

mouth commonly result in broken teeth, bitten lips or tongue and uncommonly, broken bones. Ears can be divided into the outer and inner portions. The outer portion we can see, the inner we cannot. Injury to the outer portion commonly results in swelling or bleeding. This is rarely serious. However, a blow over the ear canal, which leads to the inner portion of the ear, may result in the rupture of the tympanic membrane and thus cause severe pain and temporary deafness.

It is most important to realize that a blow to ANY part of the head, if severe enough, will result in unconsciousness. This must be seen as a serious injury ALWAYS because even though this may only be a minor concussion, it may also be a sign of impending death.

THE NECK (*Mok*)

The neck can be seen as a connecting stem between the head, the brain and the rest of the body. It functions as a support of the head as well as a conduit. The support is accomplished by the cervical (neck) spine. This is the first part of the vertebral column (back bone). The other parts are: thoracic (chest) spine, lumbar (abdominal) spine, sacral (the part between the two hip bones) spine and the coccyx.

The cervical spine consists of seven vertebrae. Inside of the vertebrae is a canal which contains the spinal cord; The nerves going to the rest of the body exit from the spinal cord between two neighboring vertebrae. Injuries to any part of the spine can lead to the fracture of a vertebra which if displaced will lead to compression or transection of nerves on the spinal cord. This in turn may result in paralysis of the muscles or the part of the body innervated by the nerve or the spinal cord. The conduit part lies in front of the cervical spine. In front of this lies the larynx and the trachea (Adam's apple and the wind pipe) which bring air to the lungs. Behind lies the esophagus (food pipe) which brings food to the stomach. On the side of these are located carotid arteries (one on each side) which take blood from the heart to the brain. Injury to the larynx, trachea or carotid arteries is extremely serious and can lead to rapid death. Injuries to the esophagus are very rare, except with a knife or gunshot wound to the neck.

SECTION OF THE BODY (*Mom Dungboon*)

Taekwon-Do training is characterized by its lack of contact. Patterns and many other attack and defence exercises are practised alone against an imaginary opponent. Even sparring is conducted without actually striking or grasping an opponent's body. Under these circumstances it would be extremely difficult, if not impossible, to specify the particular vital spot to be attacked. Furthermore, it would be almost impossible to standardize the location of the hand or foot of the student for attack or defence. To alleviate these problems, the human body has been imaginarily divided into three sections: the high, above the neck; the middle, between the shoulders and umbilicus; and the low, below the umbilicus.

Within these areas are a number of vital spots. In each area, the most accessible vital spot is used to categorize each section: i.e. philtrum for high, solar plexus for middle, and groin for low.

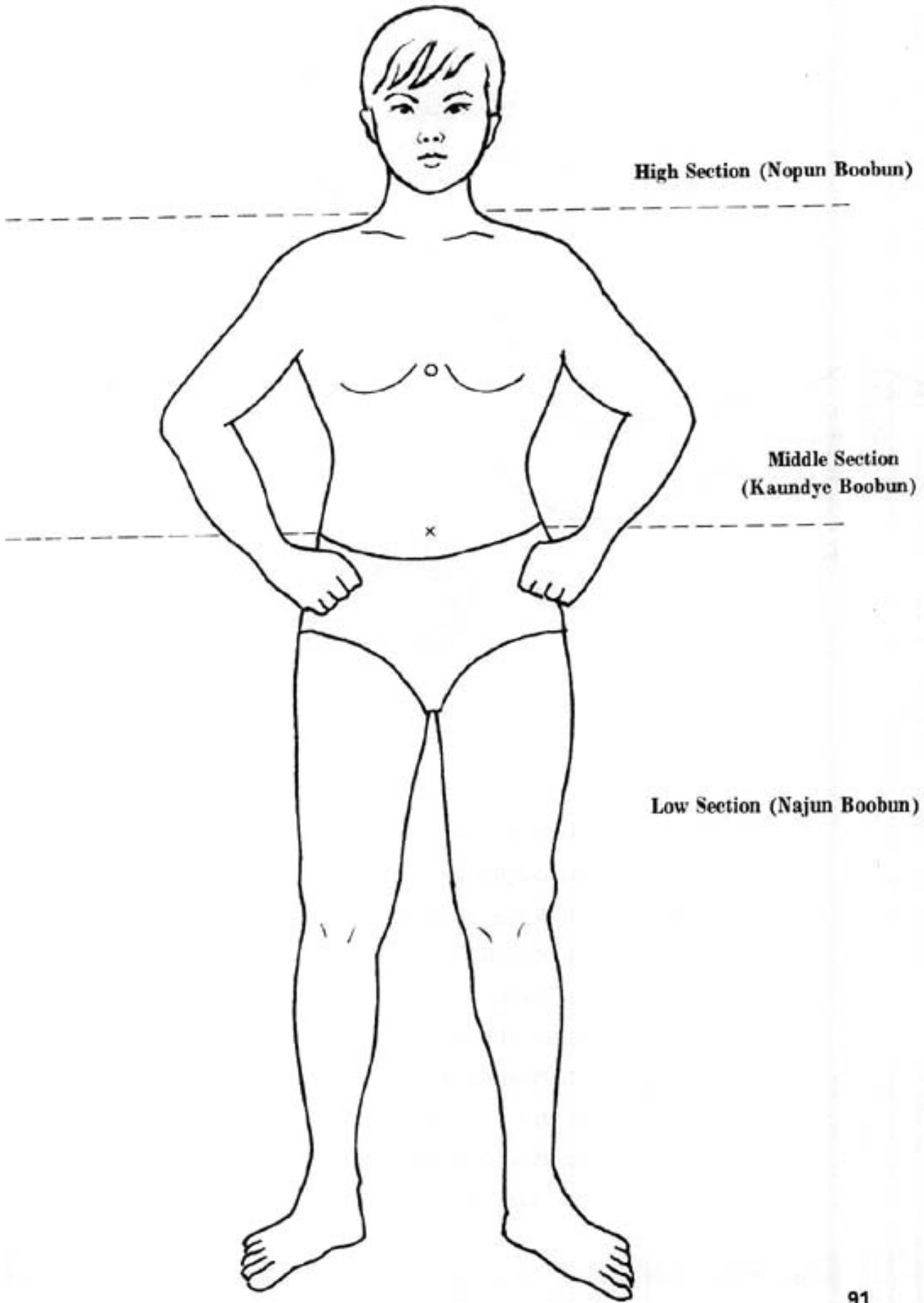

High Section (Nopun Boobun)

**Middle Section
(Kaundye Boobun)**

Low Section (Najun Boobun)

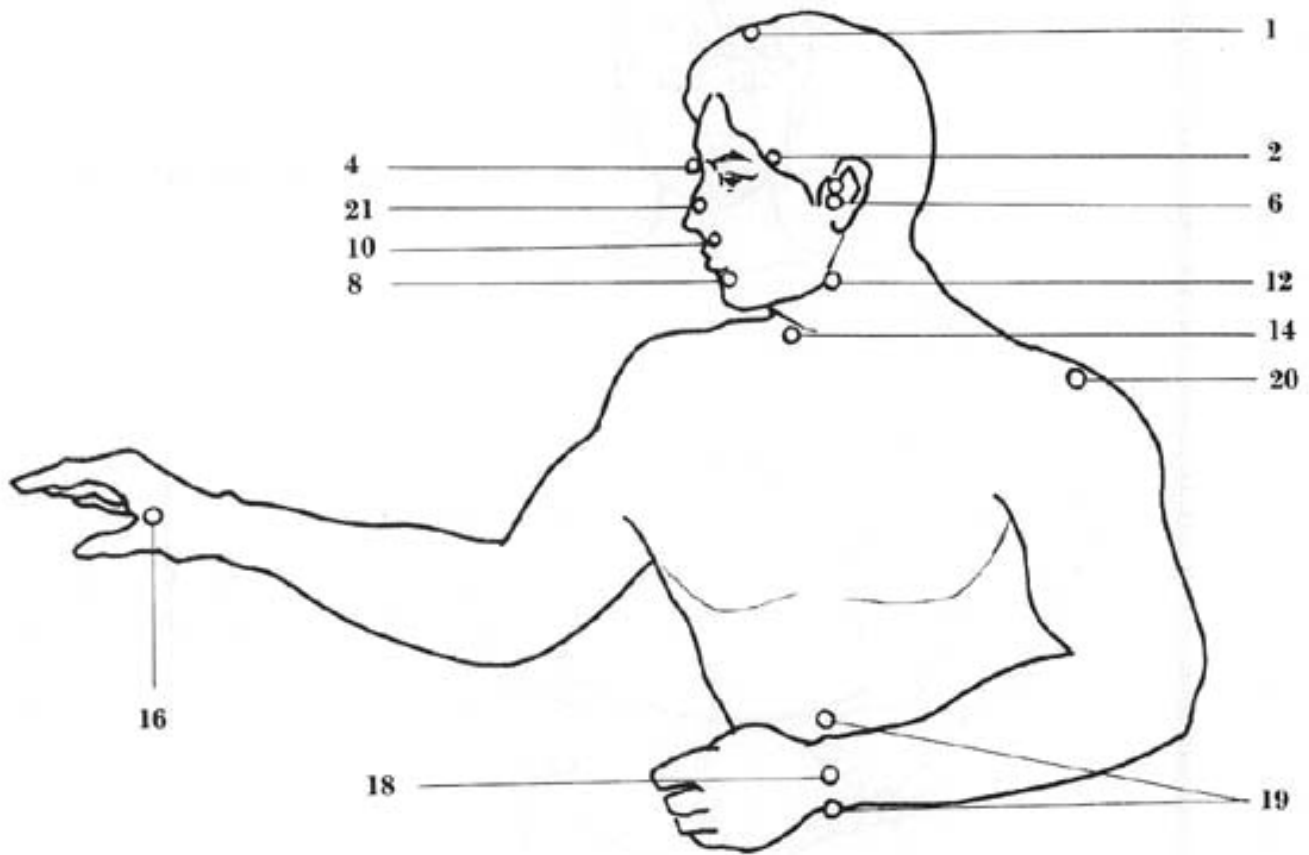

1. Skull (*Dae sin moon*)
2. Temple (*Gwanja nori*)
3. Bridge of the nose (*Migan*)
4. Eyeball (*Angoo*)
5. Mastoid (*Hoo-i-boo*)
6. Mandibula (*Tok gwanjol*)
7. Philtrum (*Injoong*)
8. Jaw (*Yop tok*)
9. Point of the chin (*Mit tok*)
10. Lips (*Ipsul*)

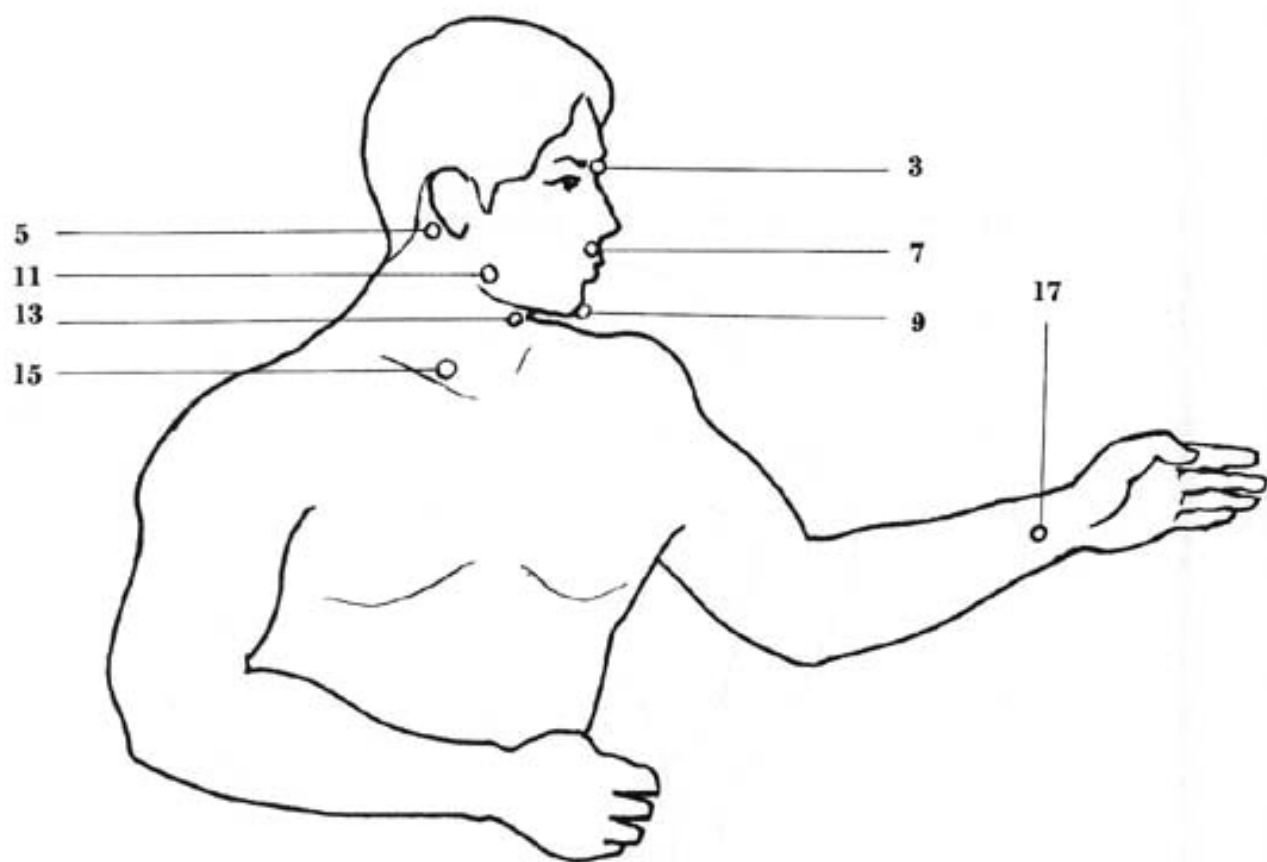

- 11. Angle of the mandible (*Wit tok*)
- 12. Upper neck (*Witmok*)
- 13. Adam's apple (*Gyol hoo*)
- 14. Windpipe (*Soom tong*)
- 15. Clavicle (*Swe gol*)
- 16. Thenar (*Umjigoo*)
- 17. Radical artery (*Maekbak sonmok dongmaek*)
- 18. Back wrist artery (*Dung sonmok dongmaek*)
- 19. Wrist joint (*Sonmok gwanjol*)
- 20. Shoulder joint (*Eukke gwanjol*)
- 21. Nose (*Kotdung*)

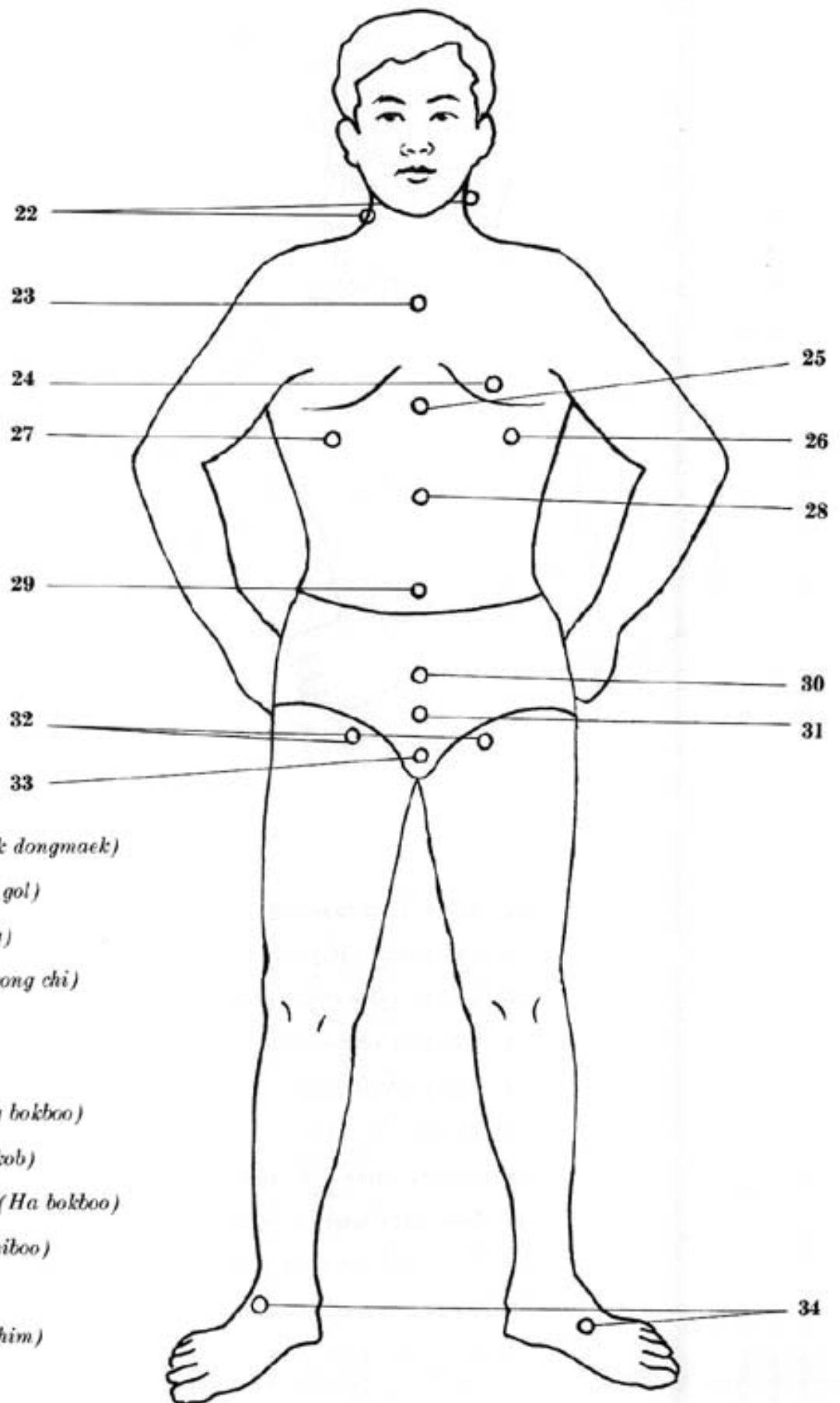

- 22. Neck artery (*Mok dongmaek*)
- 23. Sternum (*Hyung gol*)
- 24. Heart (*Shim jang*)
- 25. Solar plexus (*Myong chi*)
- 26. Spleen (*Bi jang*)
- 27. Liver (*Gan jang*)
- 28. Epigstrium (*Sang bokboo*)
- 29. Umbilicus (*Baekkob*)
- 30. Lower Abdomen (*Ha bokboo*)
- 31. Pubic region (*Chiboo*)
- 32. Groin (*Sataguni*)
- 33. Scrotum (*Nang shim*)
- 34. Instep (*Baldung*)

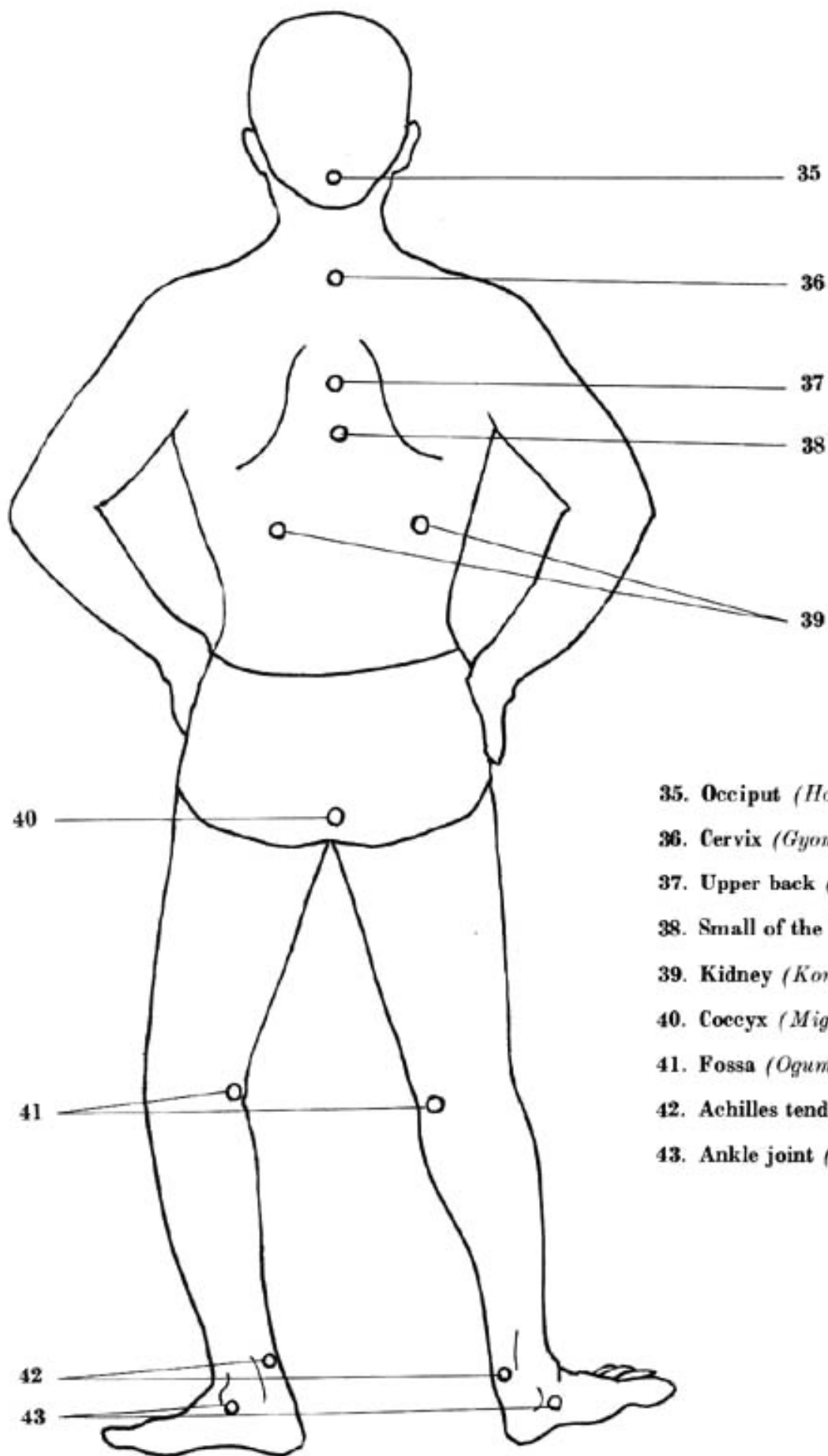

- 35. Occiput (*Hoodoo*)
- 36. Cervix (*Gyong boo*)
- 37. Upper back (*Gyon gap*)
- 38. Small of the back (*Gyong chu*)
- 39. Kidney (*Kongpat*)
- 40. Coccyx (*Migol*)
- 41. Fossa (*Ogum*)
- 42. Achilles tendon (*Dwichuk himjool*)
- 43. Ankle joint (*Balmok gwanjol*)

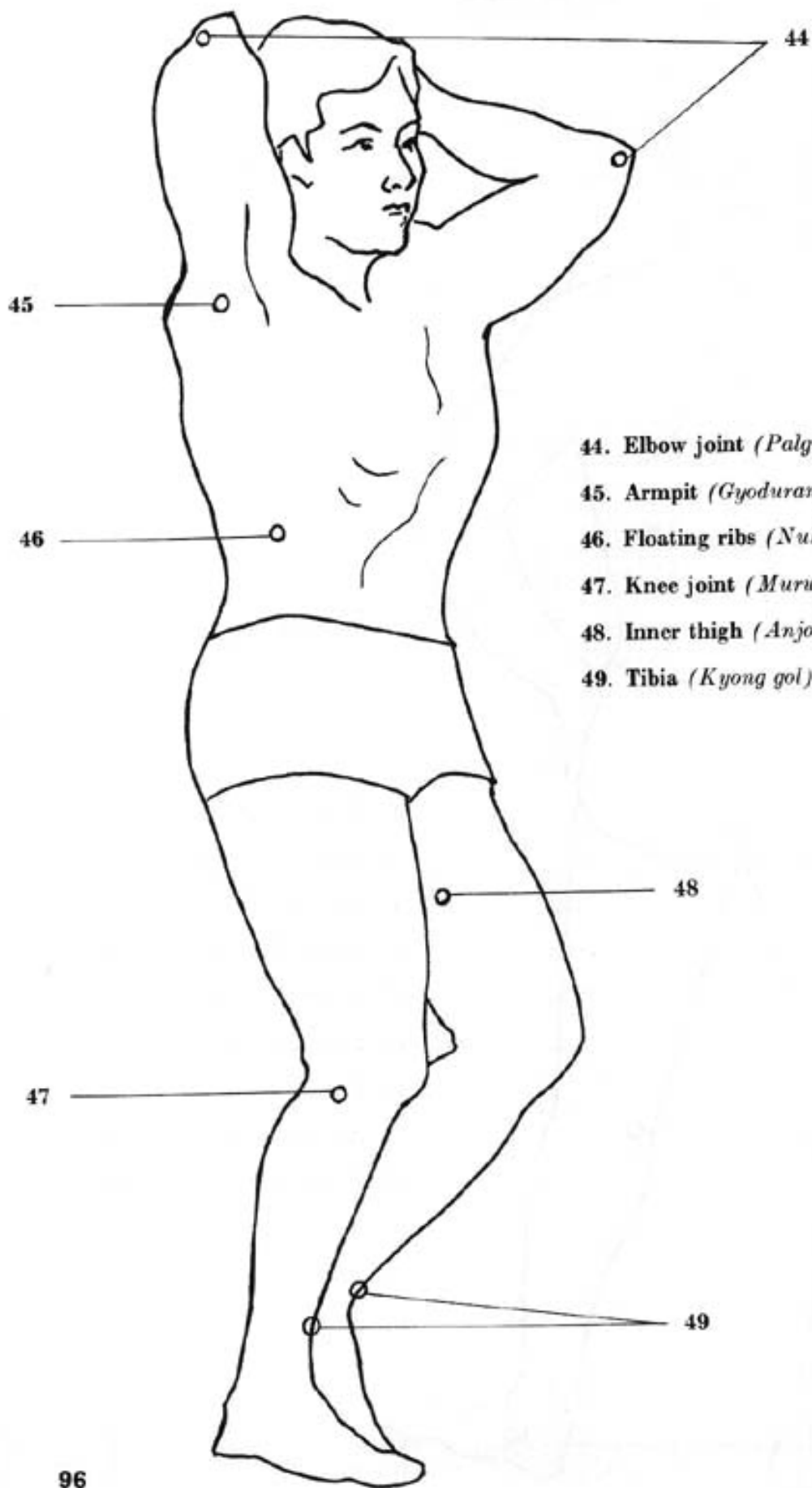

- 44. Elbow joint (*Palgup gwanjol*)
- 45. Armpit (*Gyodurang*)
- 46. Floating ribs (*Nuk gol*)
- 47. Knee joint (*Murup gwanjol*)
- 48. Inner thigh (*Anjok hobok dari*)
- 49. Tibia (*Kyong gol*)

CHECK LIST (*Daejo Pyo*)

The various check lists shown in this chapter should help the student to use the correct attacking tool against the proper target. The relationship between attacking tools and vital spots, and blocking tools and the portions to be blocked are specifically illustrated.

In Taekwon-Do, the uses of the attacking tools against the vital spots are decided on a scientific basis, according to the structure of the human body. If the student knows how and where to use each tool, he or she should be able to achieve the desired result with a minimum of expended energy. If not used correctly, however, the result may be analogous to a carpenter using a hammer instead of a saw for cutting or a chisel instead of a plane for smoothing wood.

It is more effective to attack a vital spot with an appropriate tool.

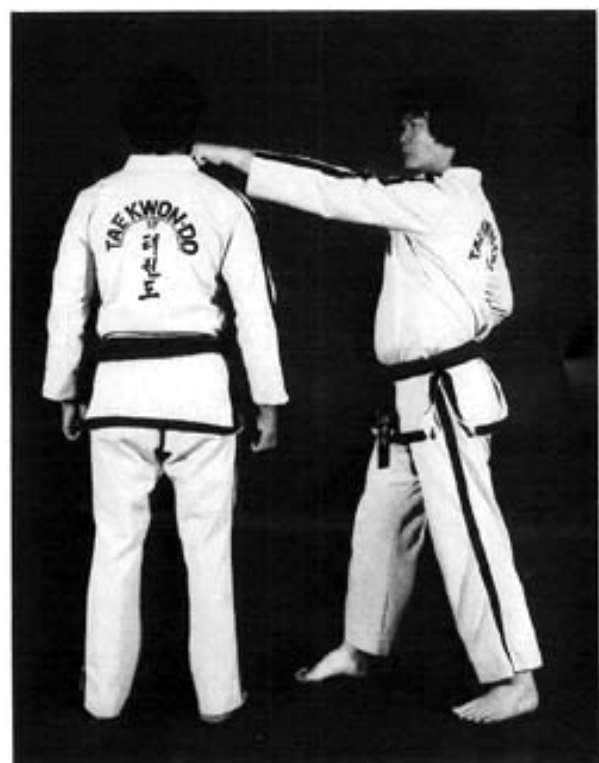

It is less effective to attack a vital spot with an inappropriate tool.



Forefinger is more effective than the forefist.

Forefist is less effective than a forefinger.



Appropriate tool is used.



Inappropriate tool is used.



Appropriate tool is used.



Inappropriate tool is used.



Appropriate tool is used.

INCORRECT



The ball of the foot is less effective than a footsword.



Block is made at a proper position with an appropriate blocking tool.

INCORRECT



Block is made at an improper position. As a result the defender is attacked.

INCORRECT



Block with an inappropriate tool; defender became off-balanced.

Block is executed at a proper position with an appropriate blocking tool.



RELATION OF ATTACKING TOOL AND VITAL SPOTS

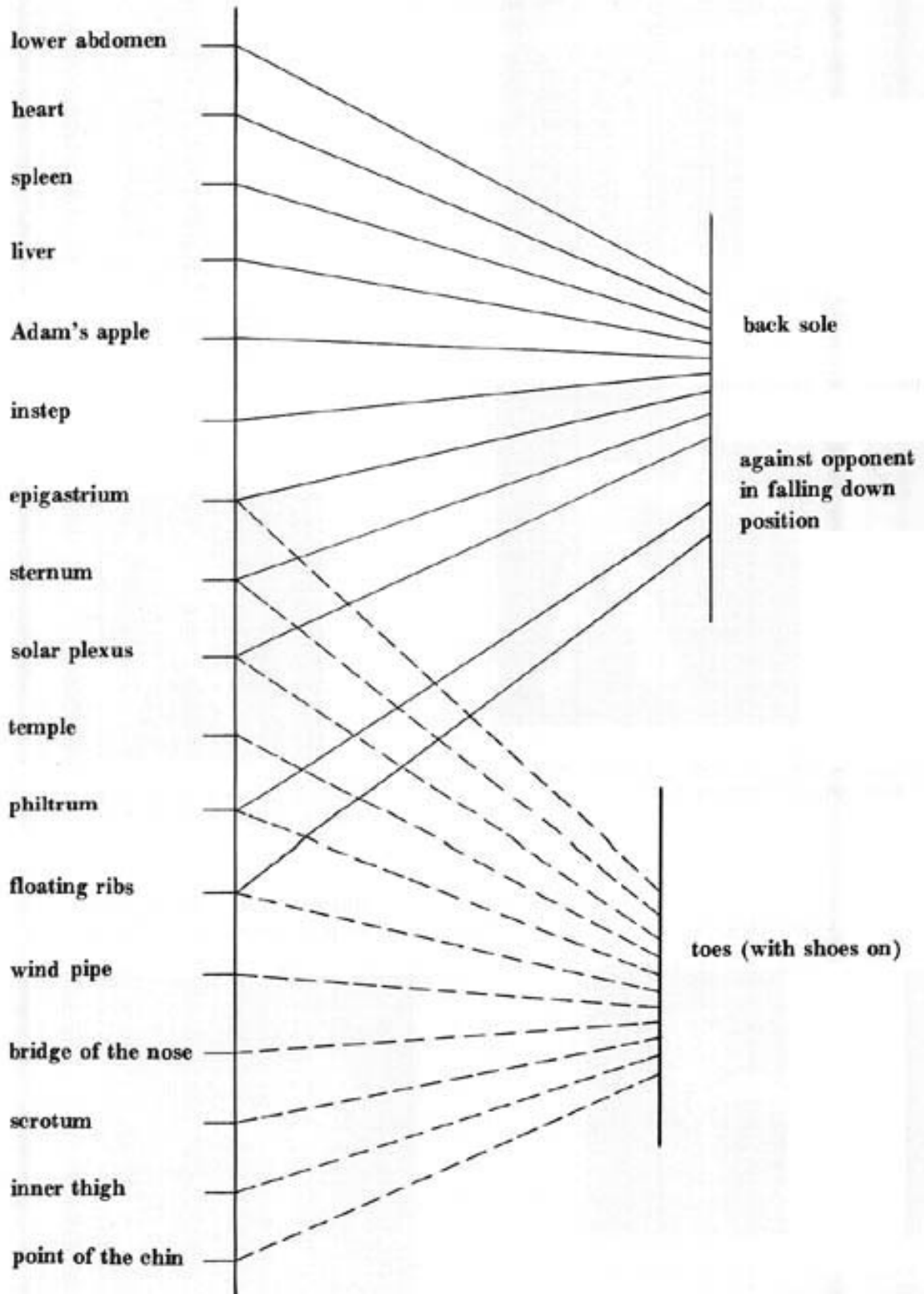

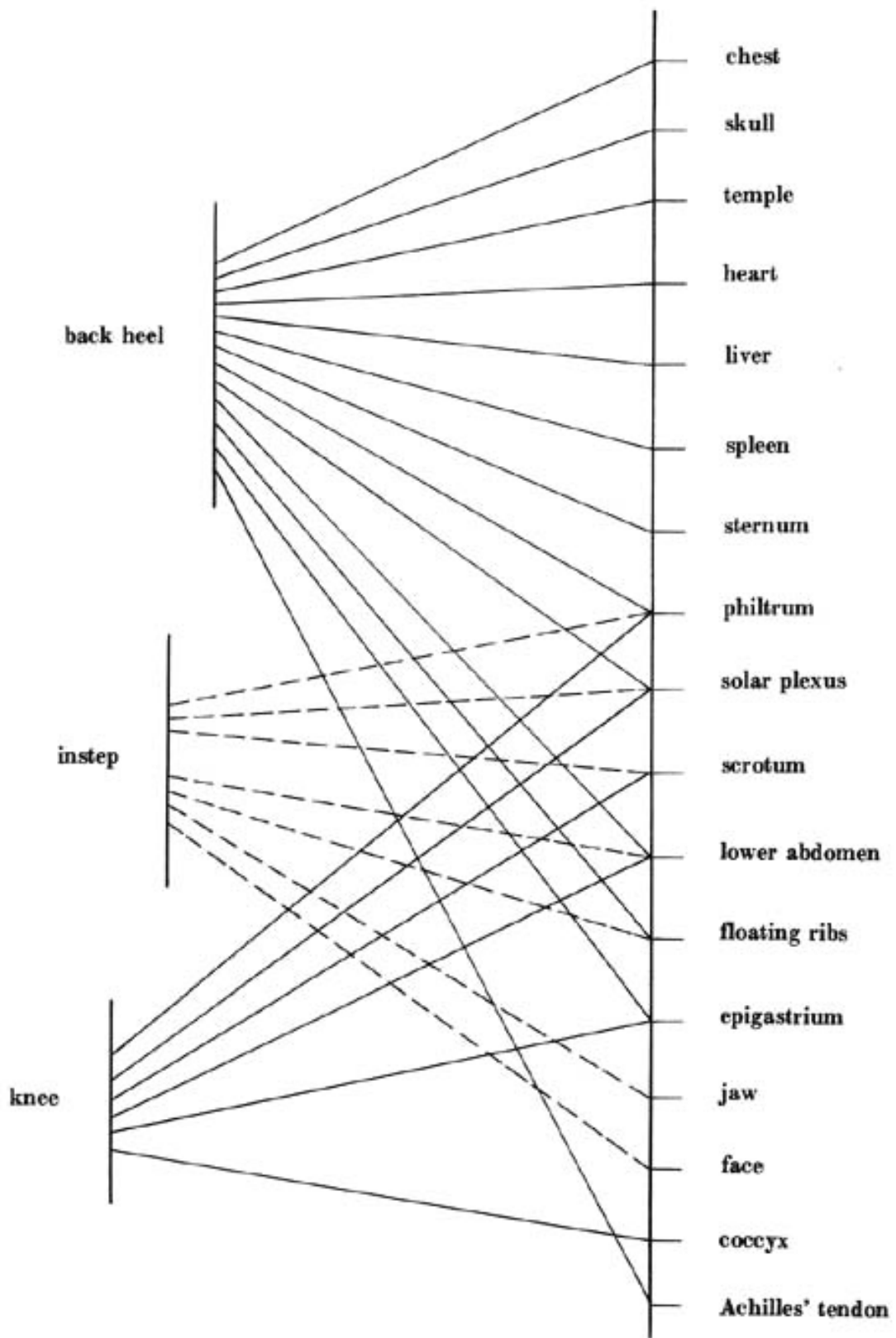

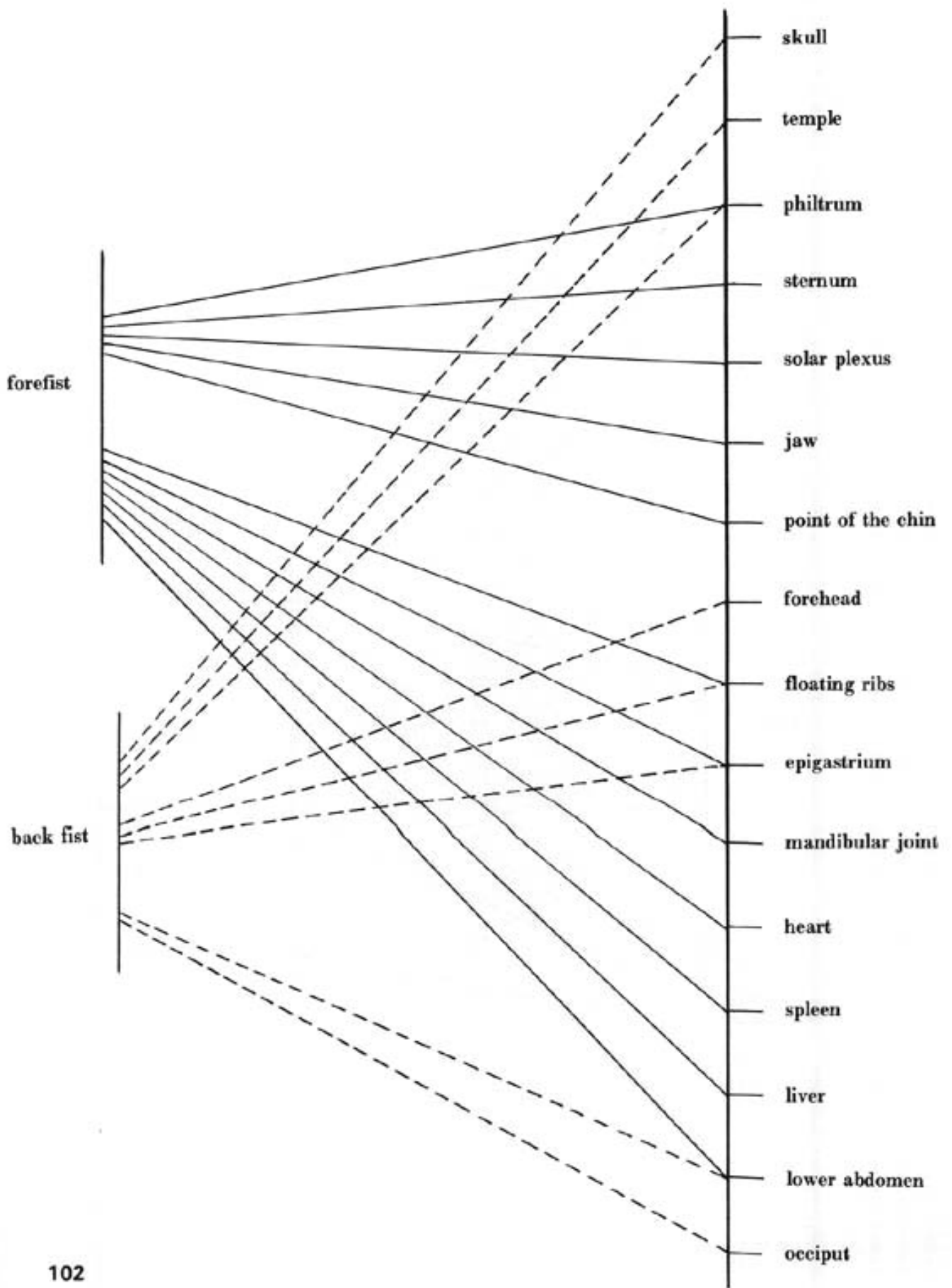

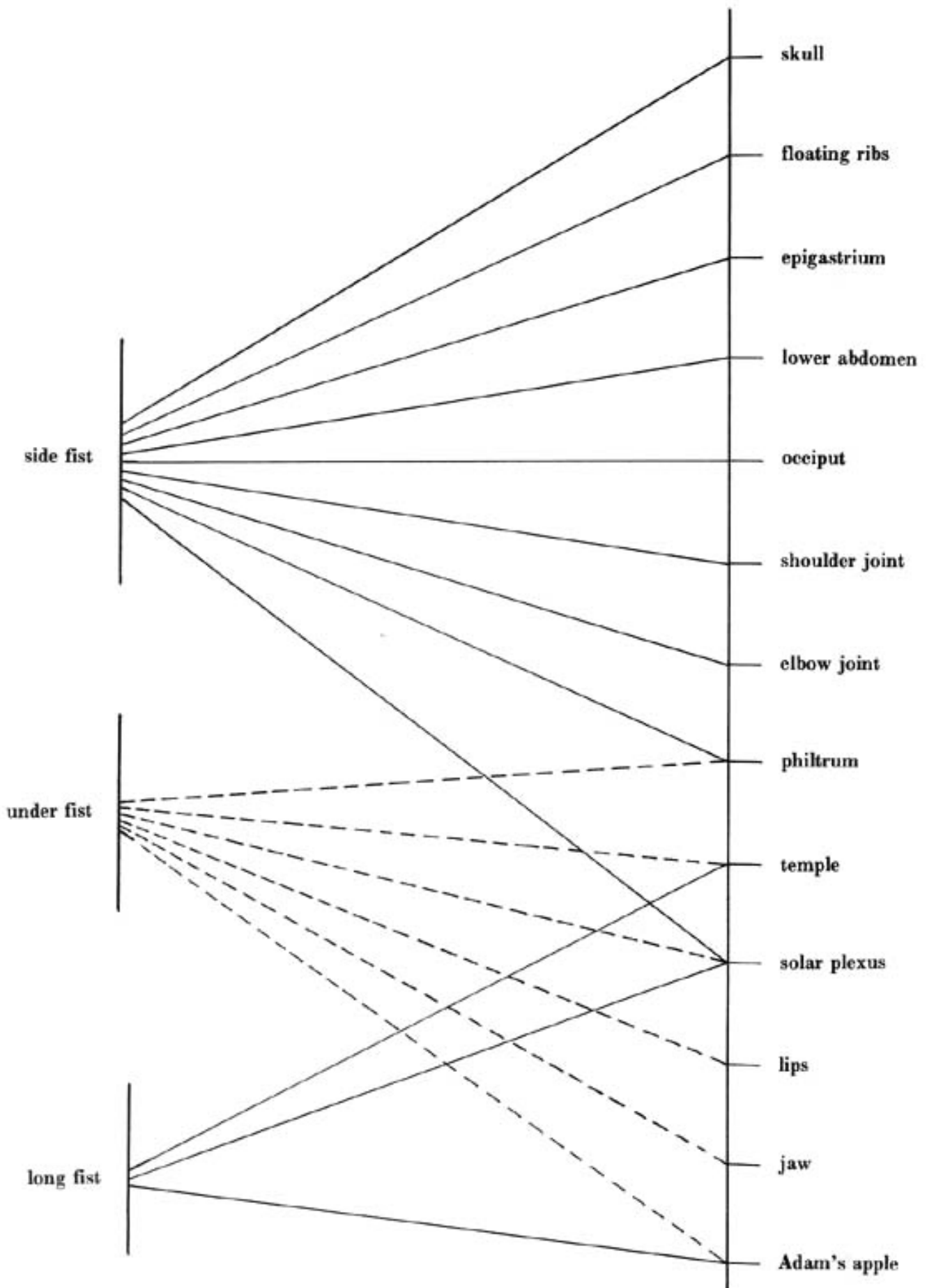

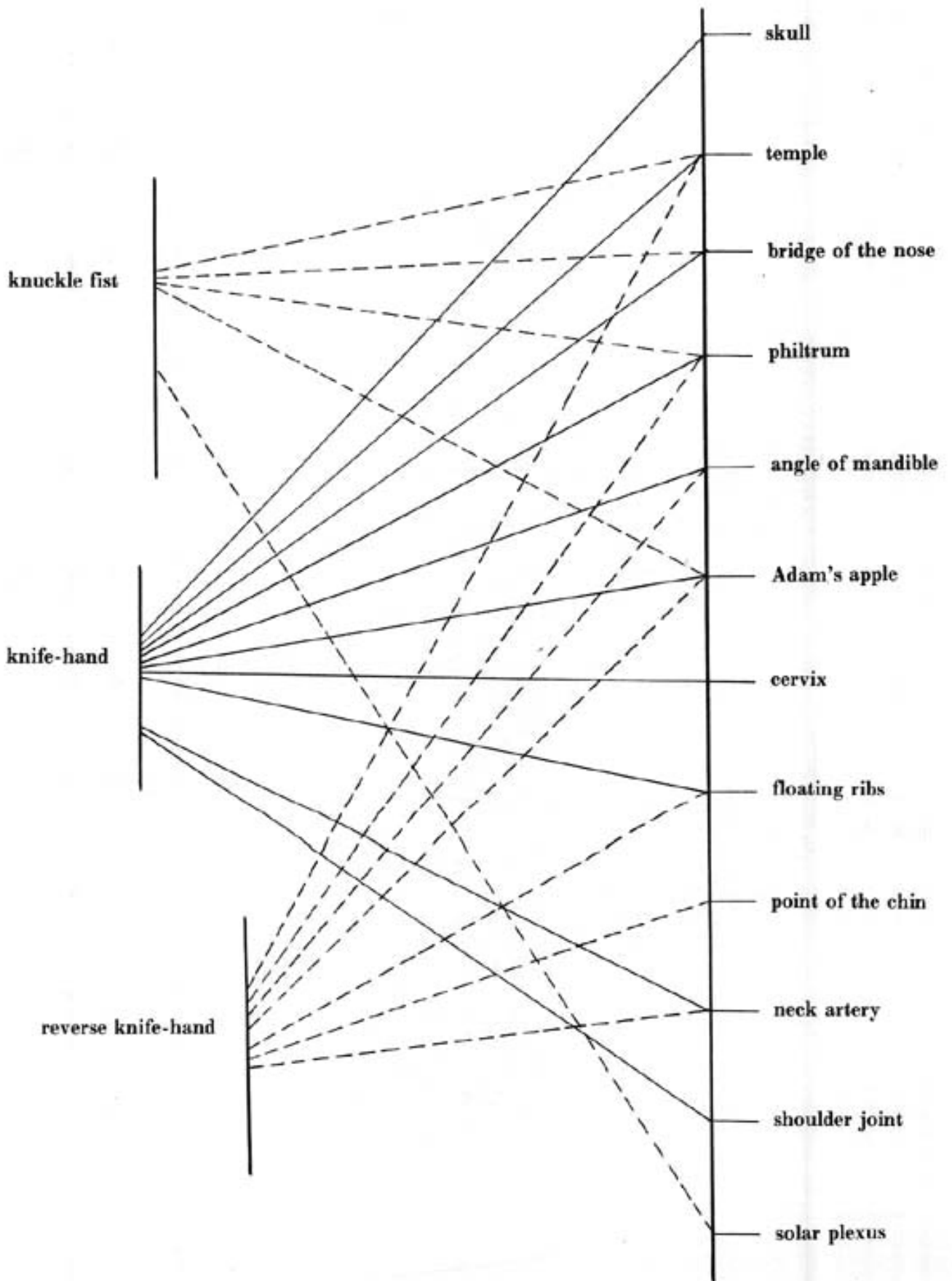

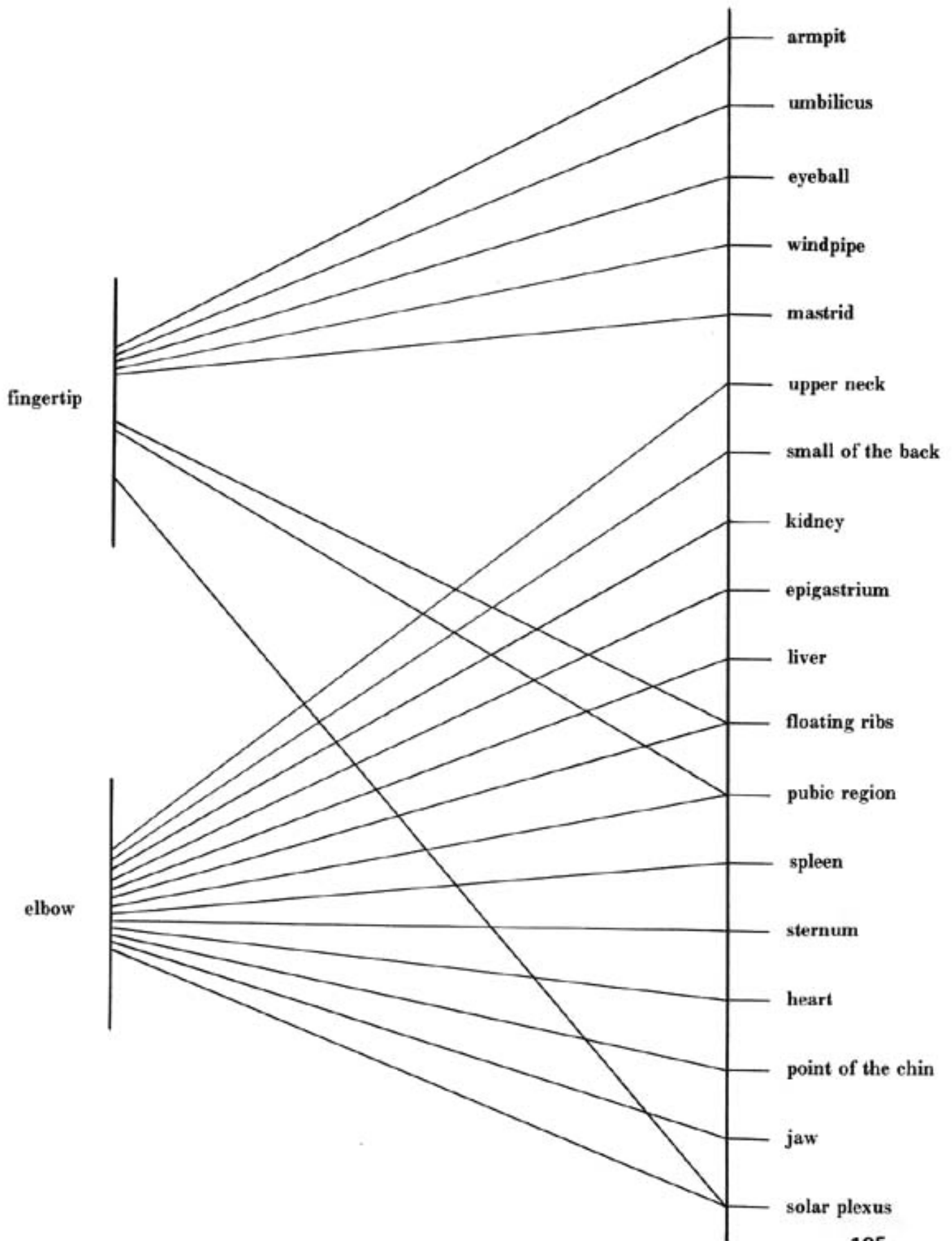

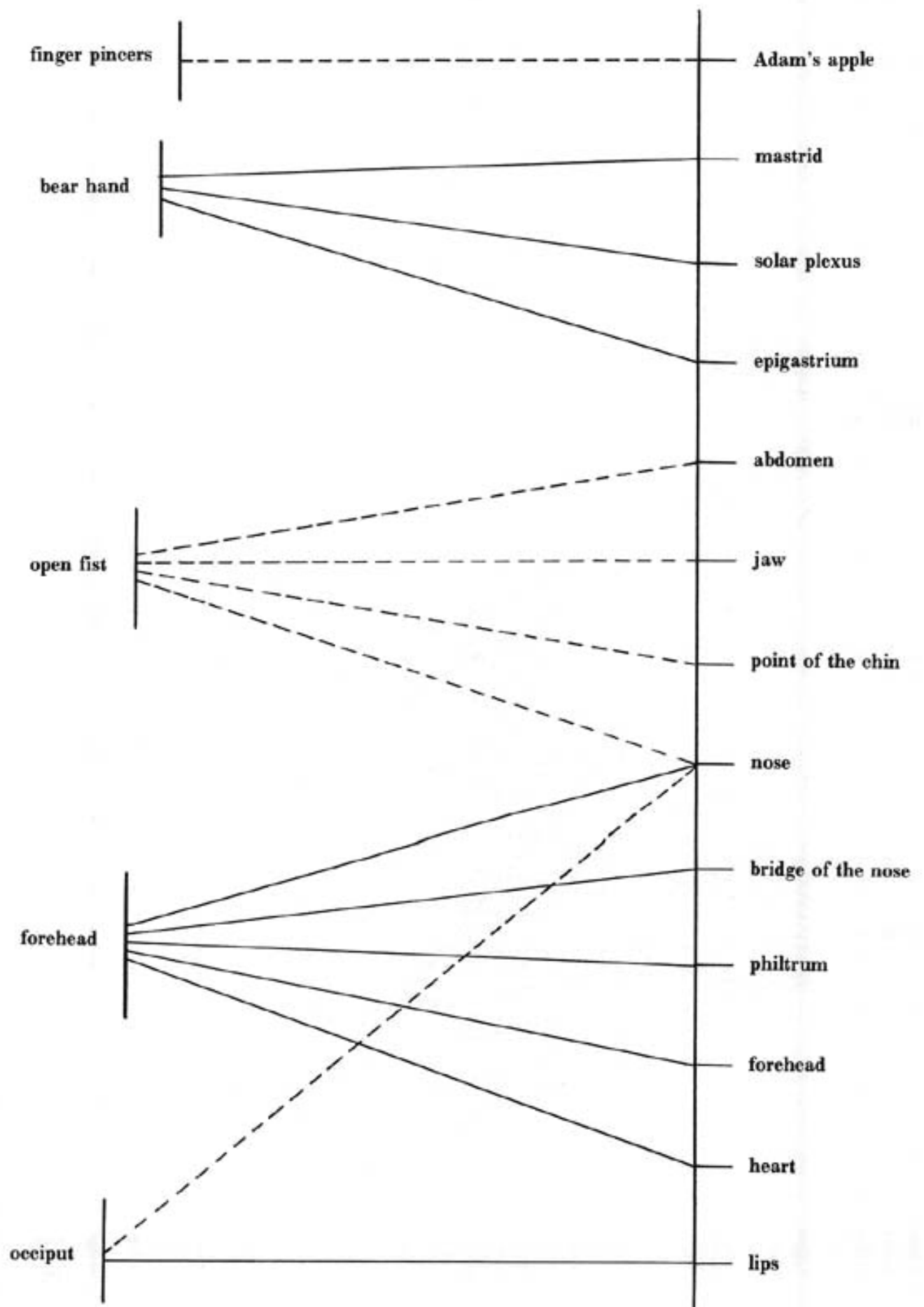

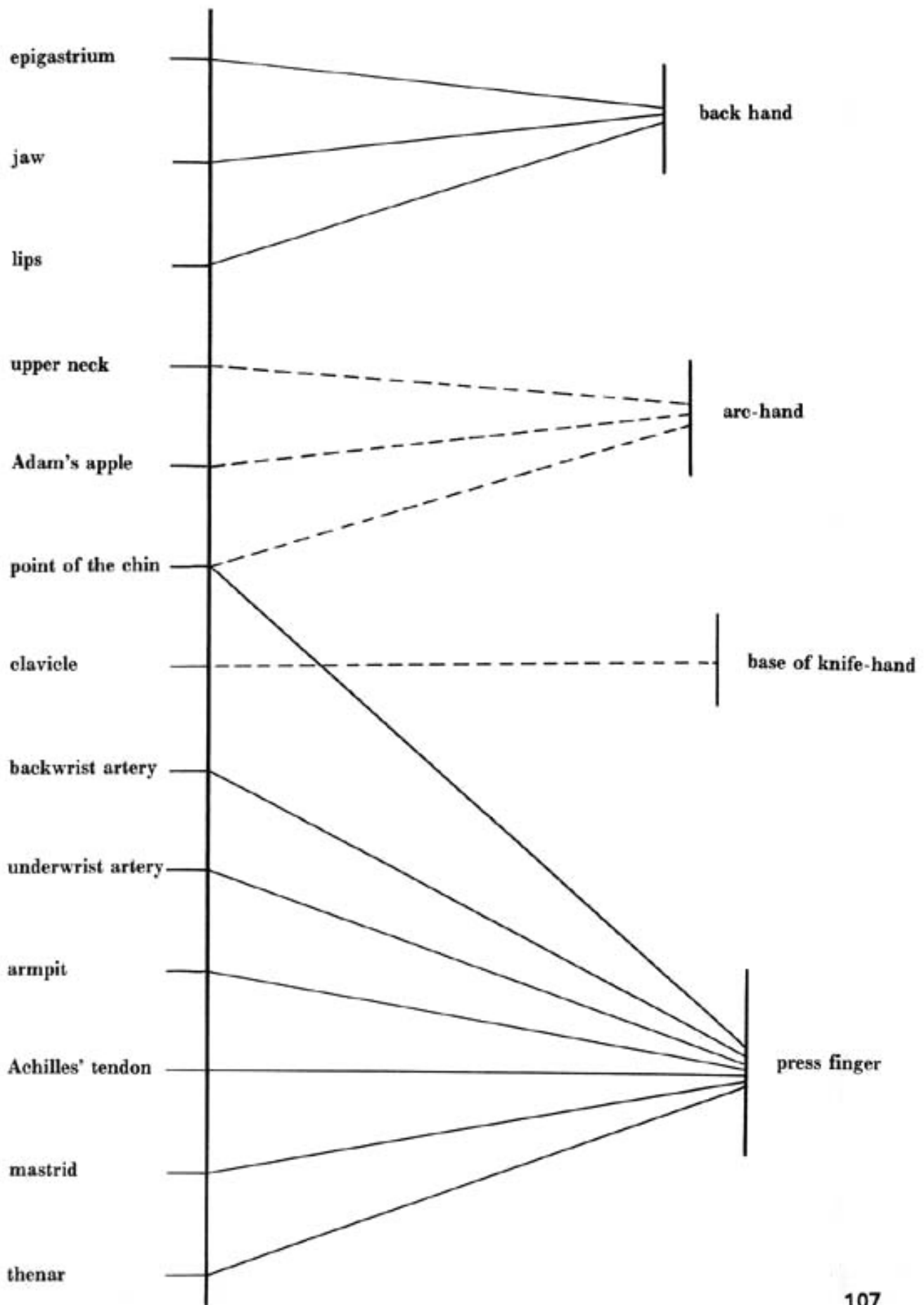

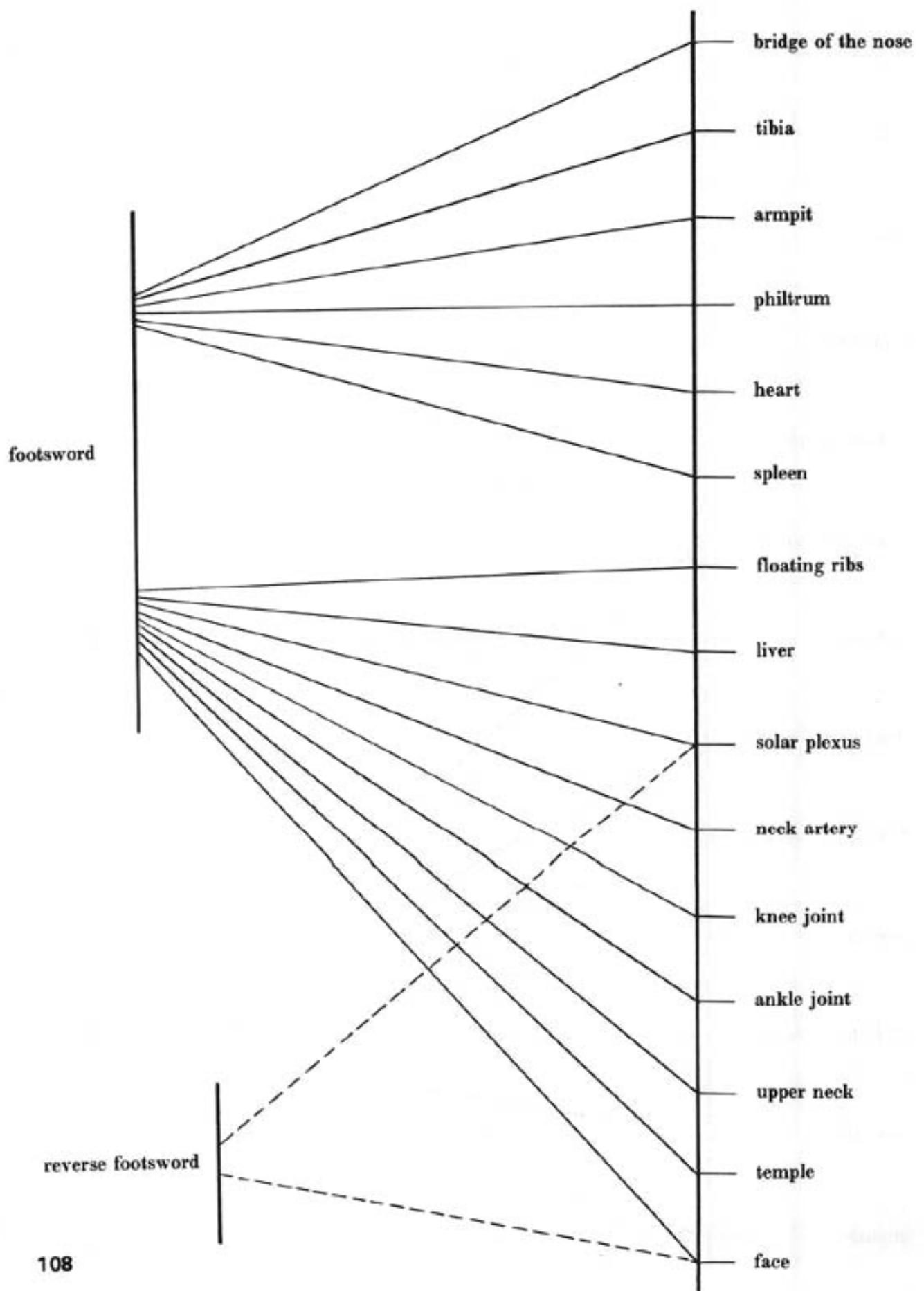

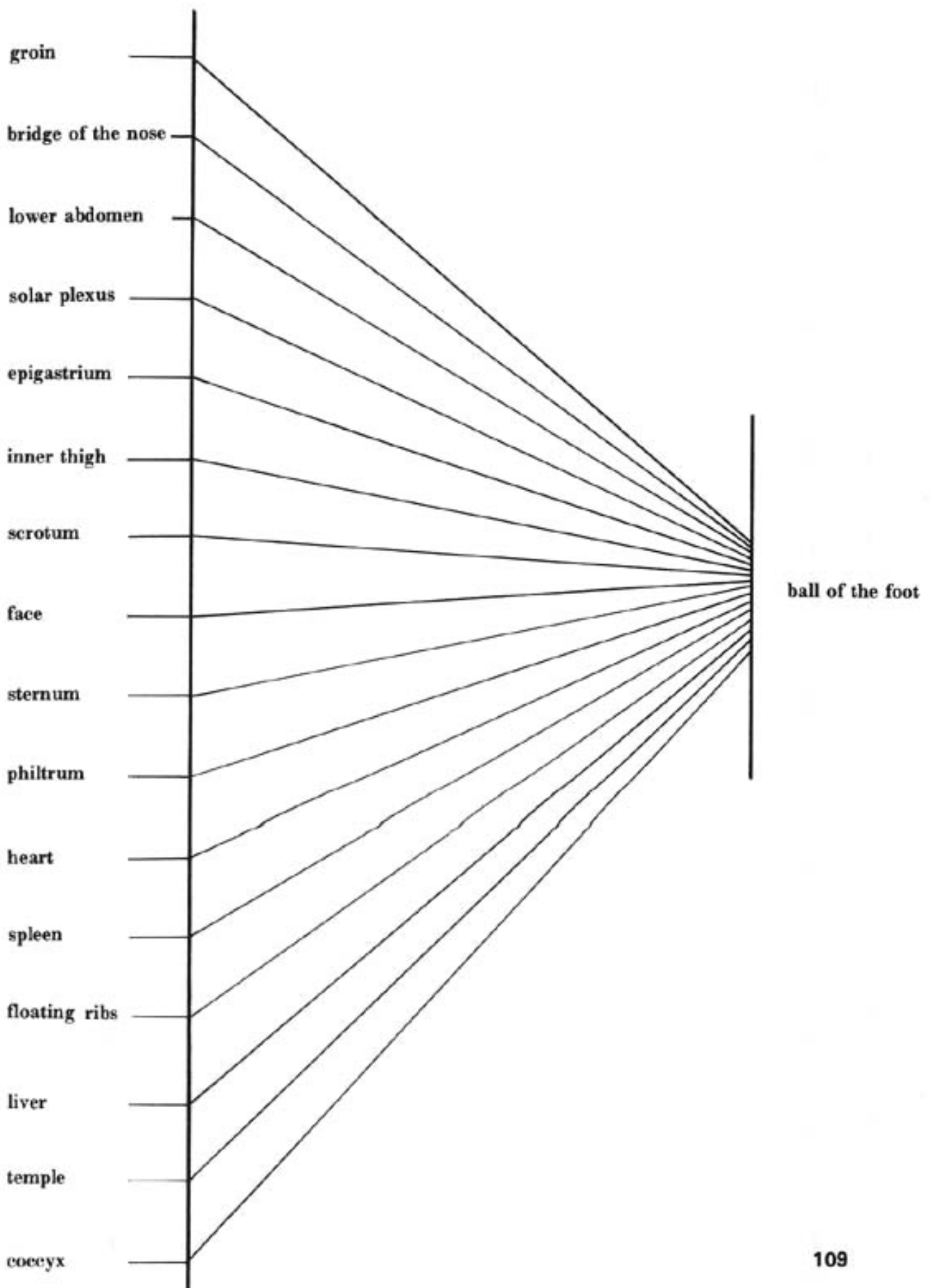

RELATION OF BLOCKING TOOL AND PORTION TO BE BLOCKED

METHOD OF BLOCKING

PORTION BLOCKED

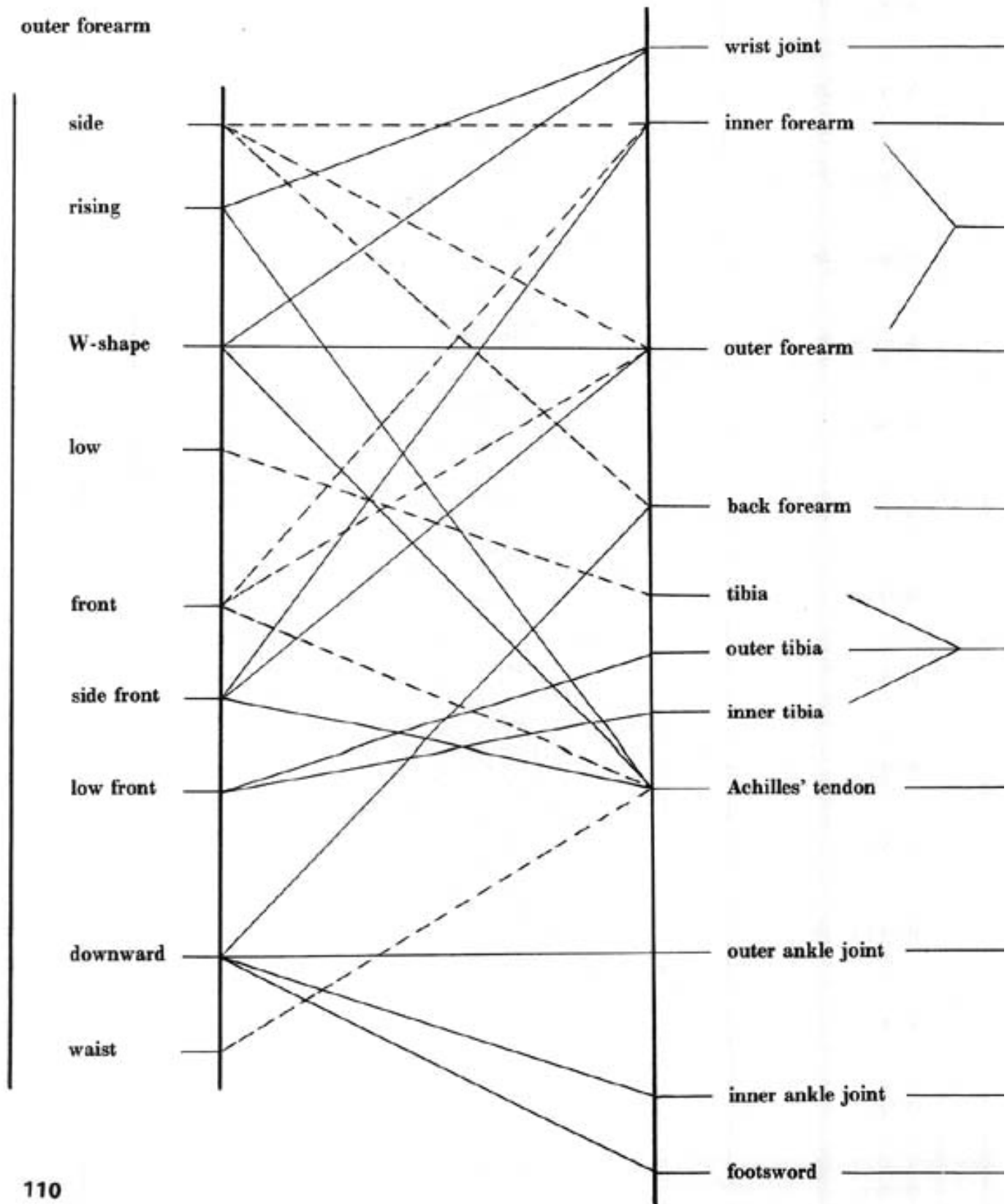

METHOD OF ATTACKING

ATTACKING TOOL

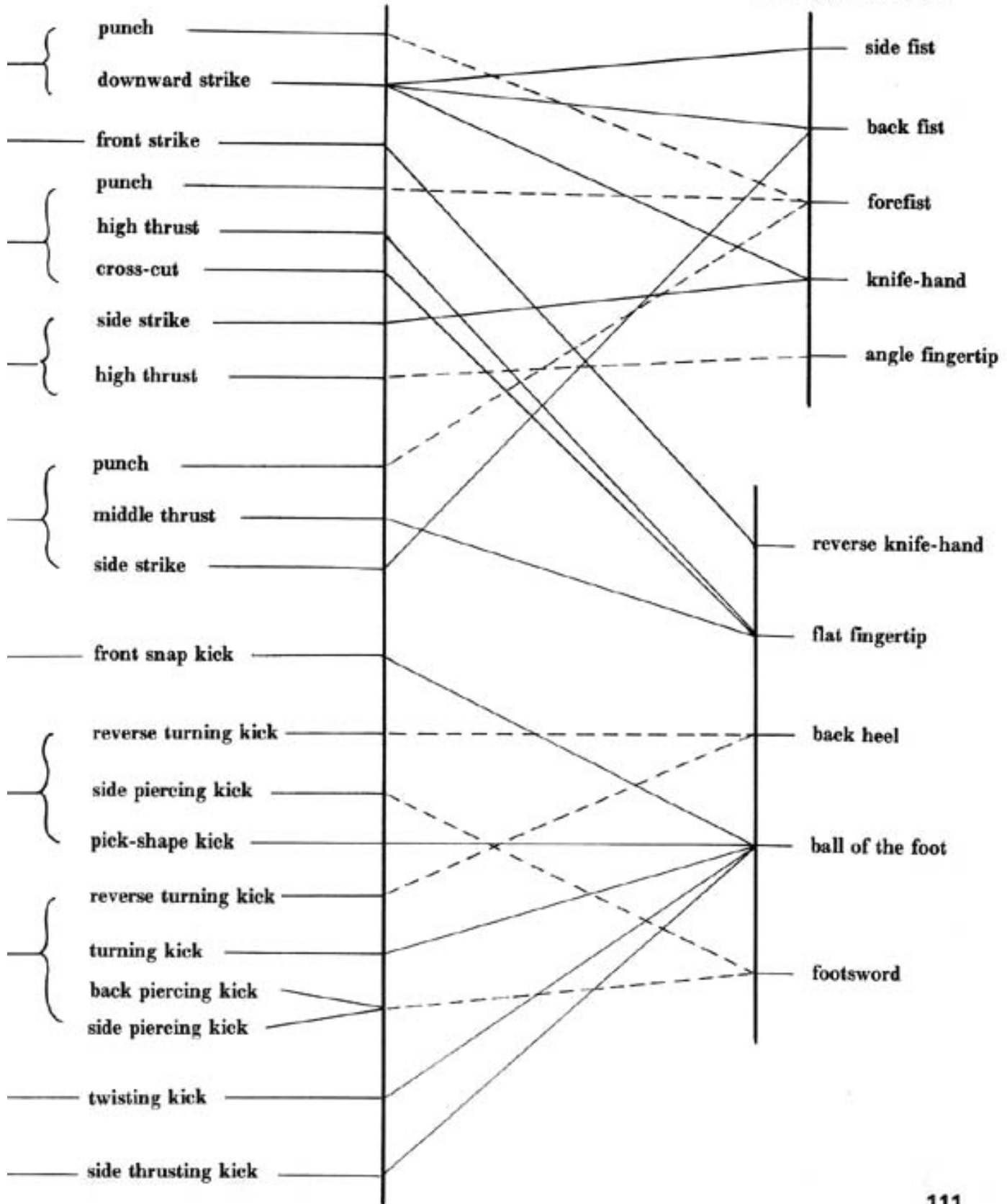

METHOD OF BLOCKING

PORTION BLOCKED

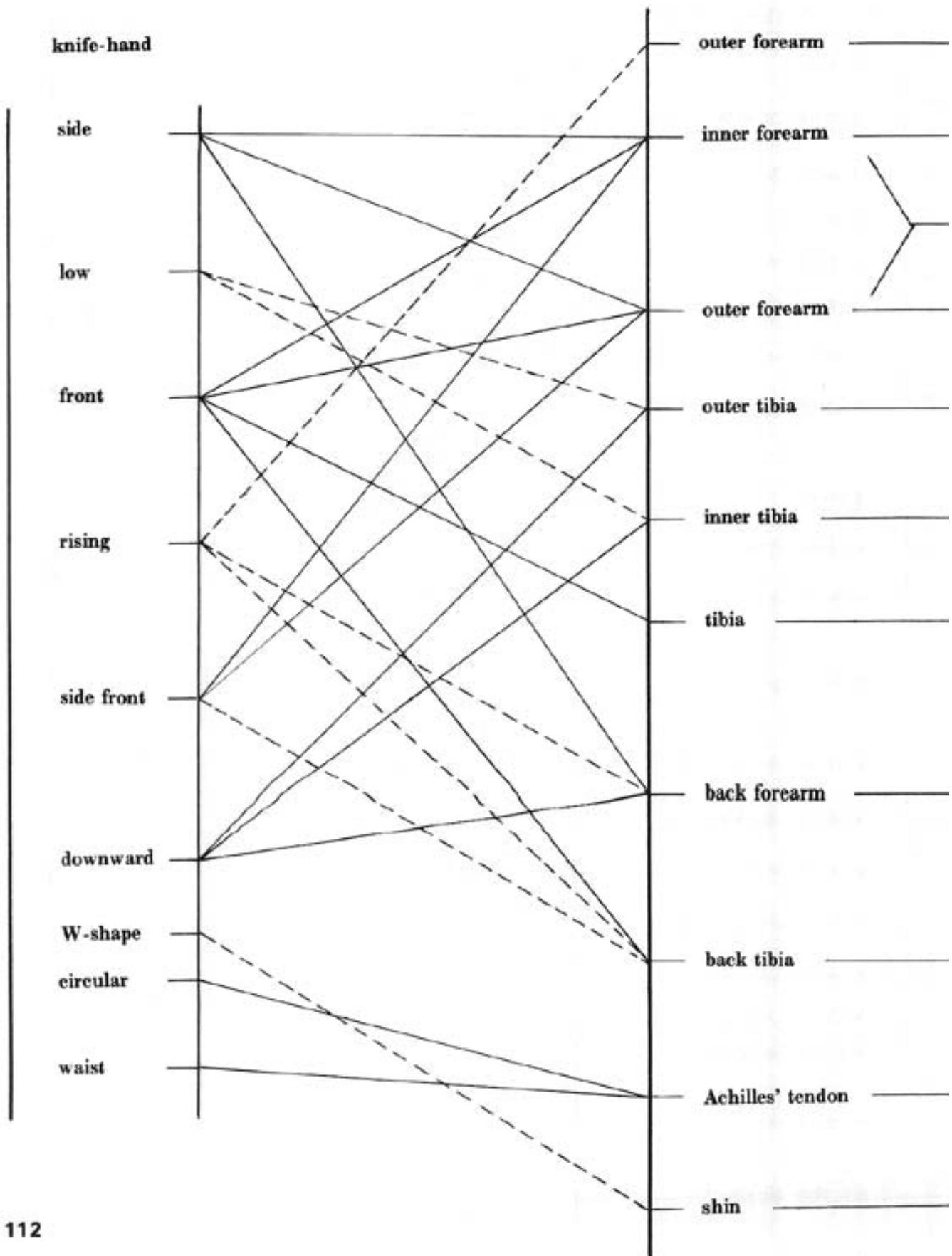

METHOD OF ATTACKING

ATTACKING TOOL

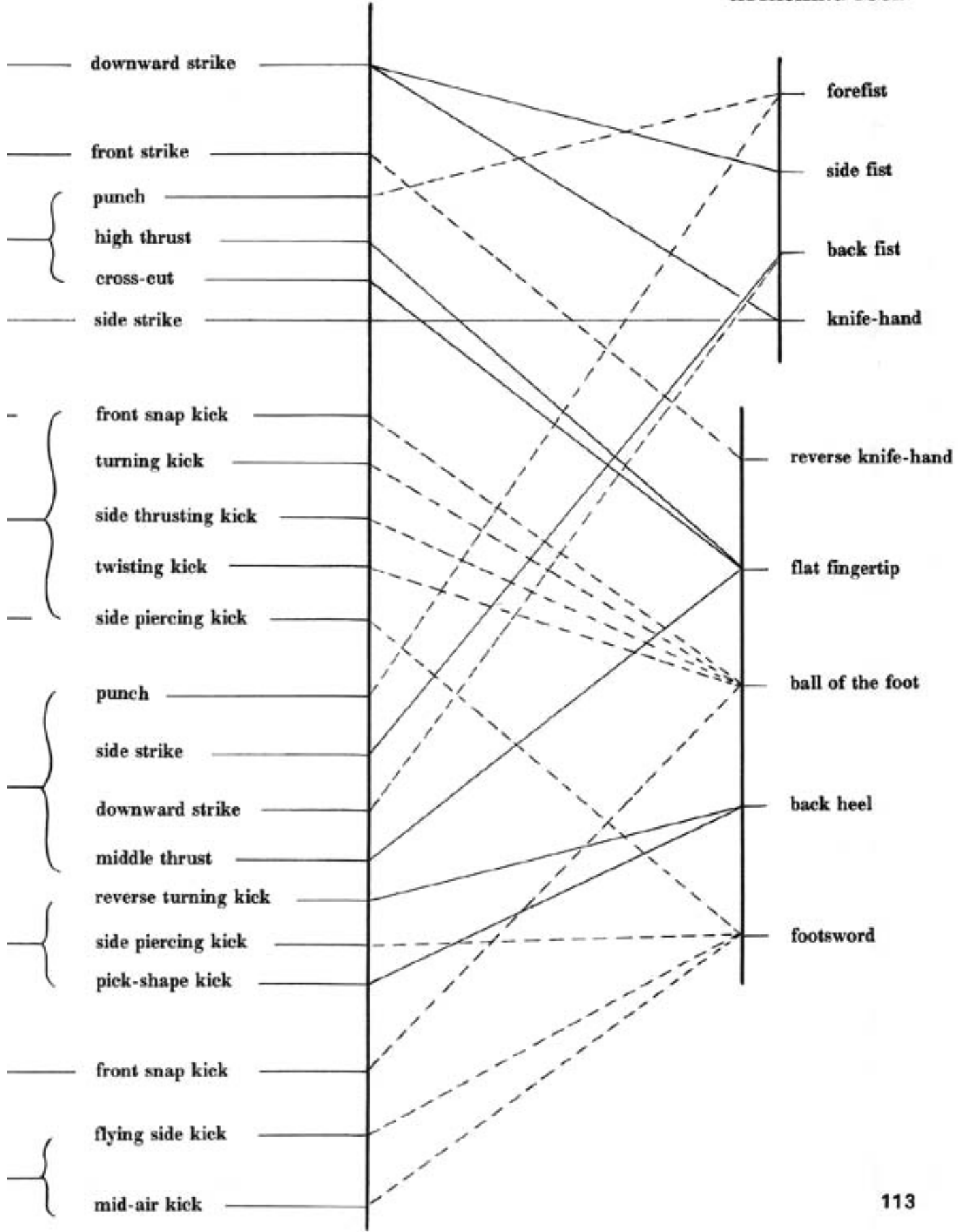

METHOD OF BLOCKING

PORZION BLOCKED

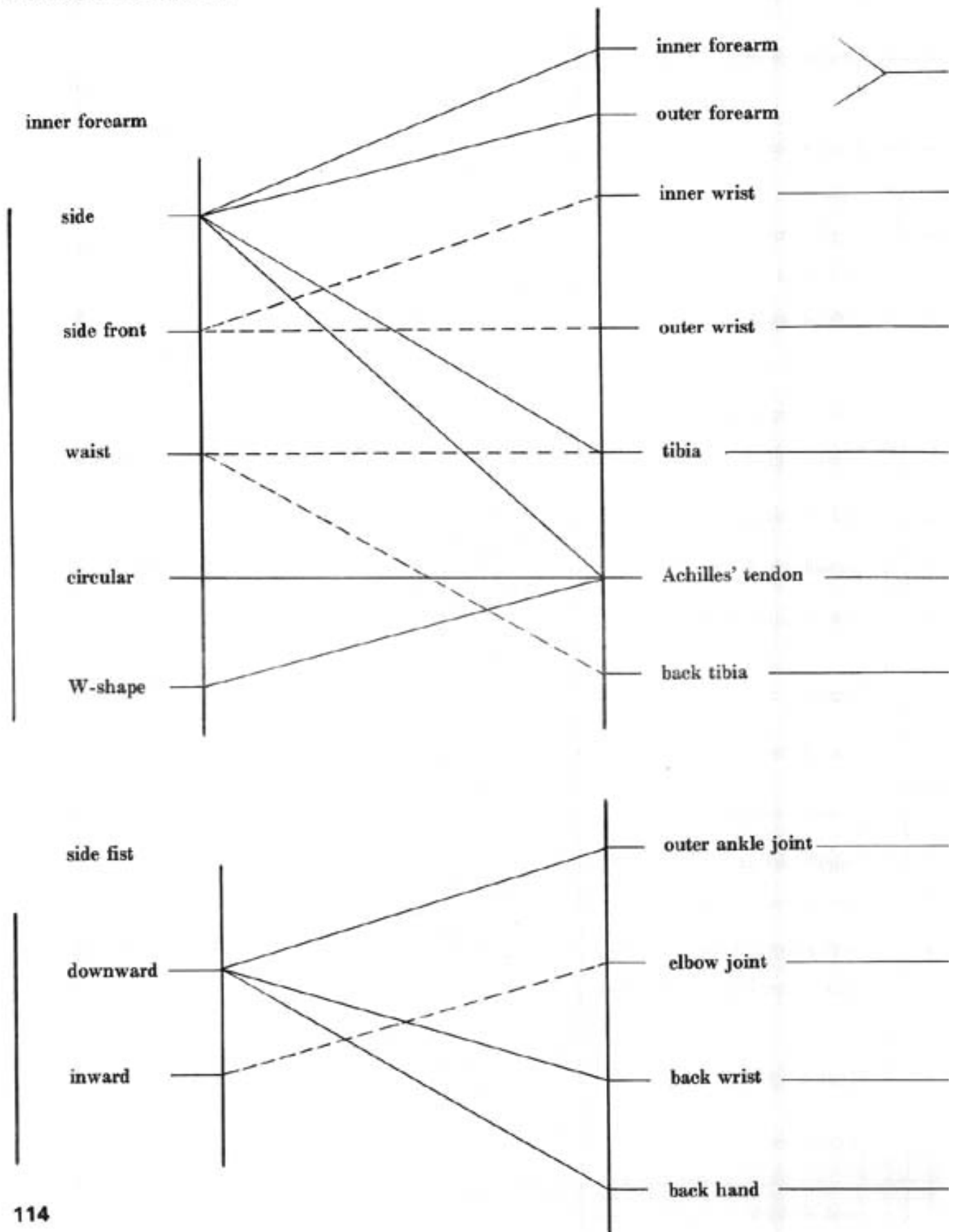

METHOD OF ATTACKING

ATTACKING TOOL

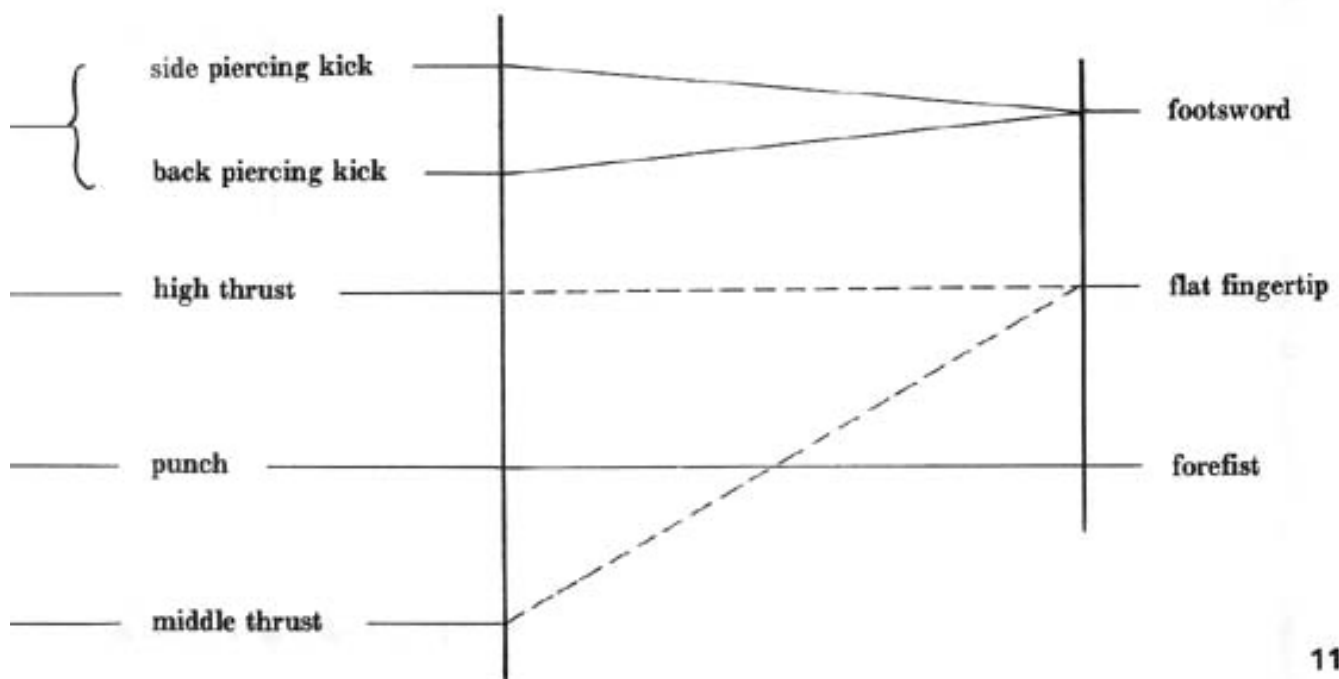
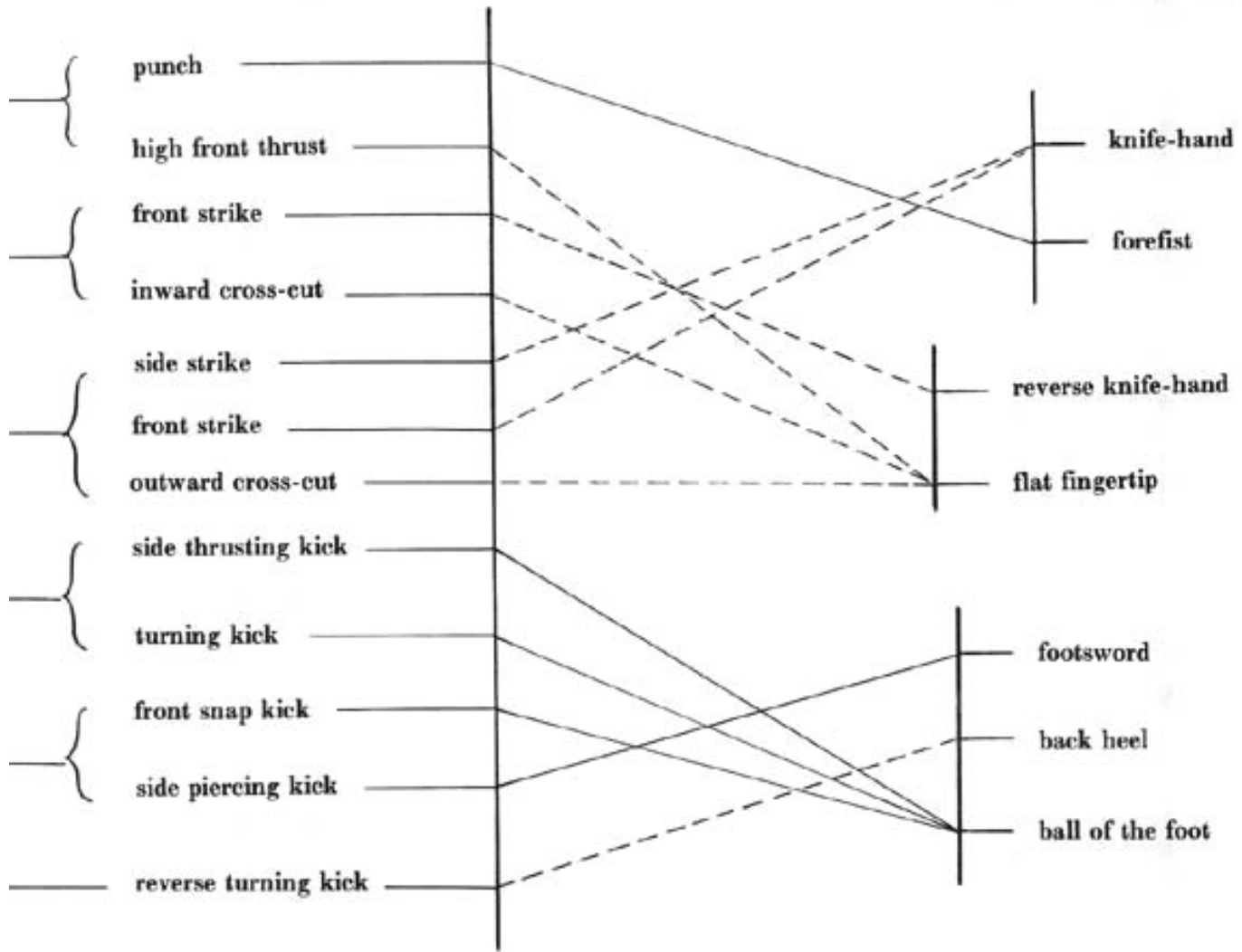

METHOD OF BLOCKING

PORTION BLOCKED

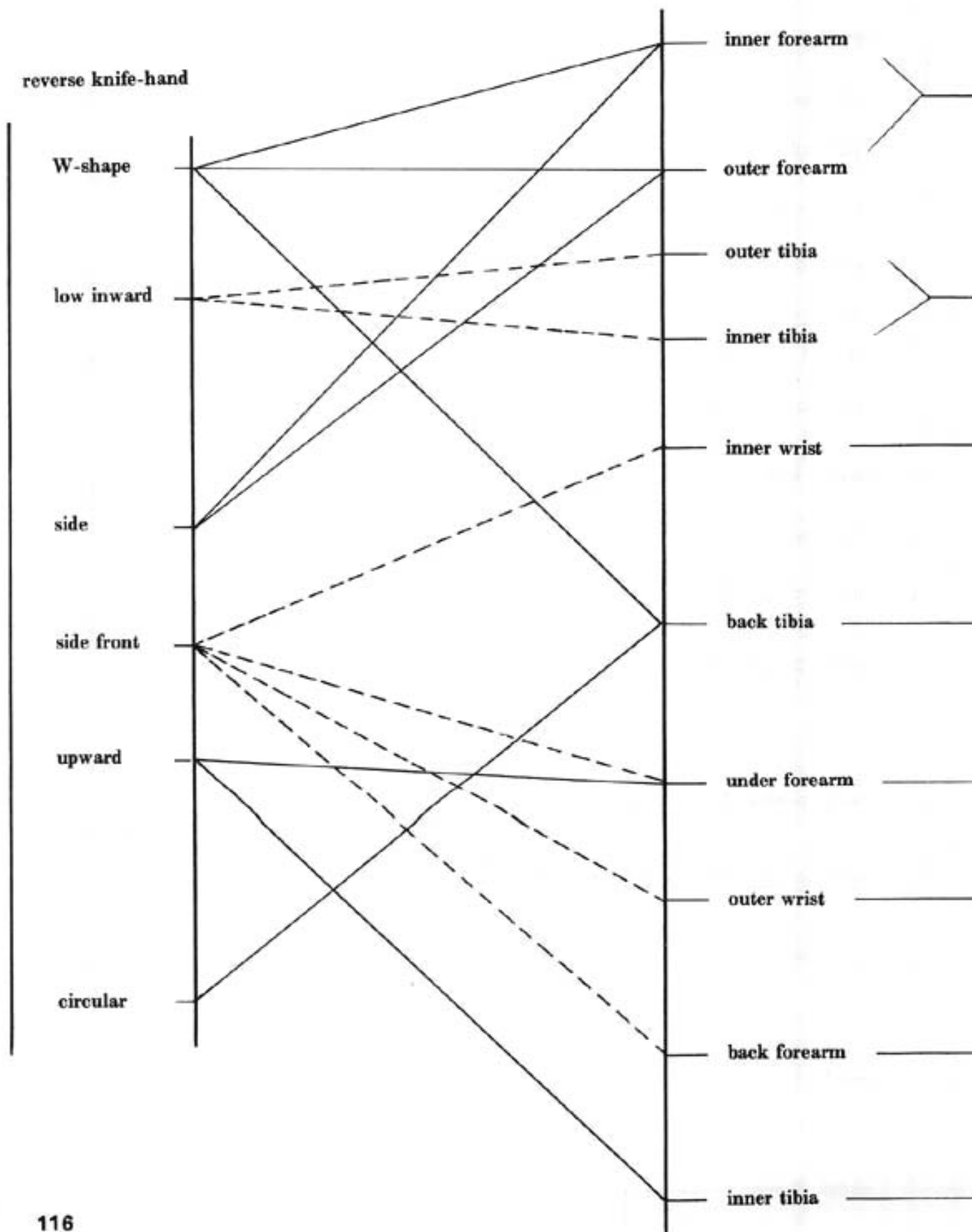

METHOD OF ATTACKING

ATTACKING TOOL

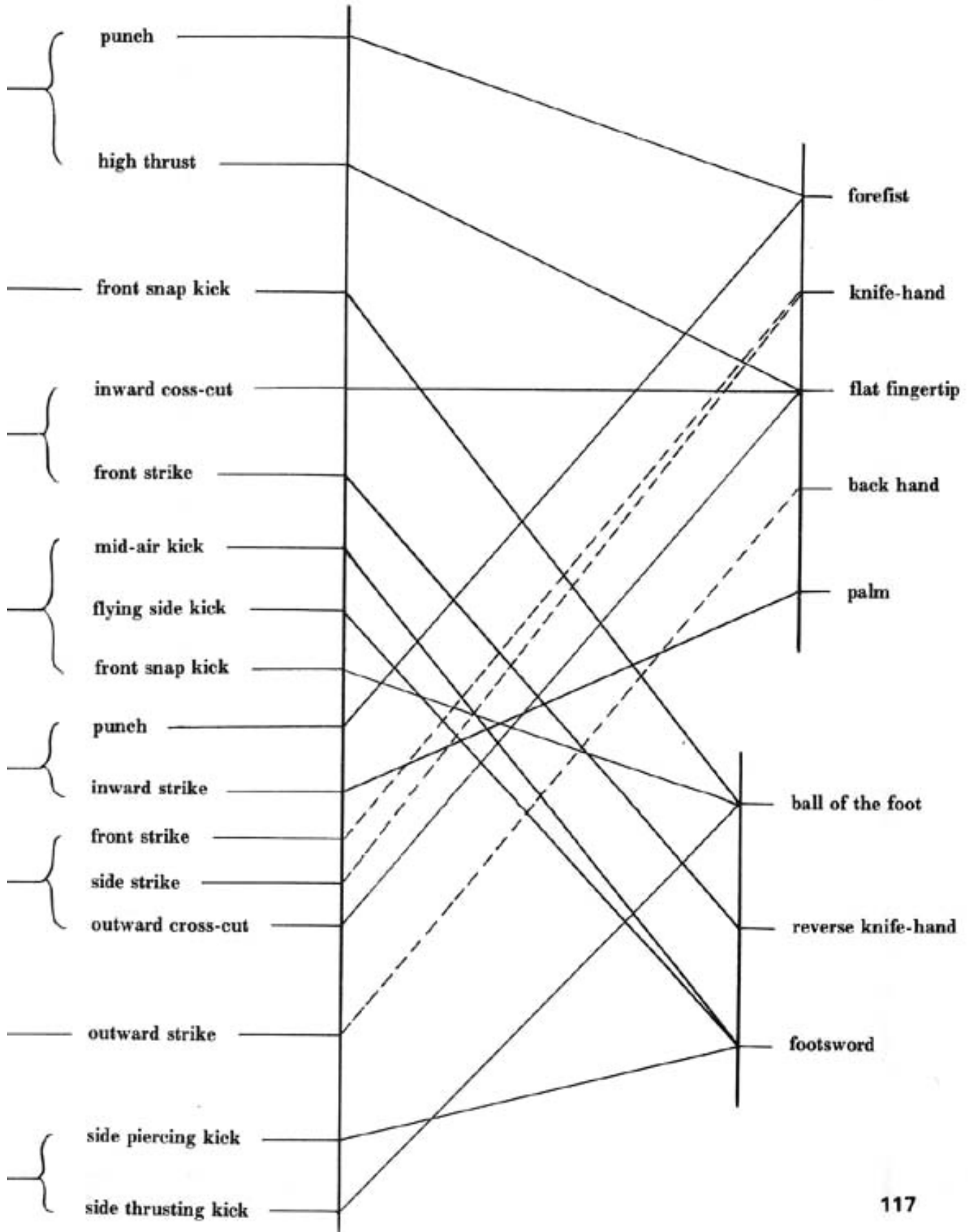

METHOD OF BLOCKING

PORTION BLOCKED

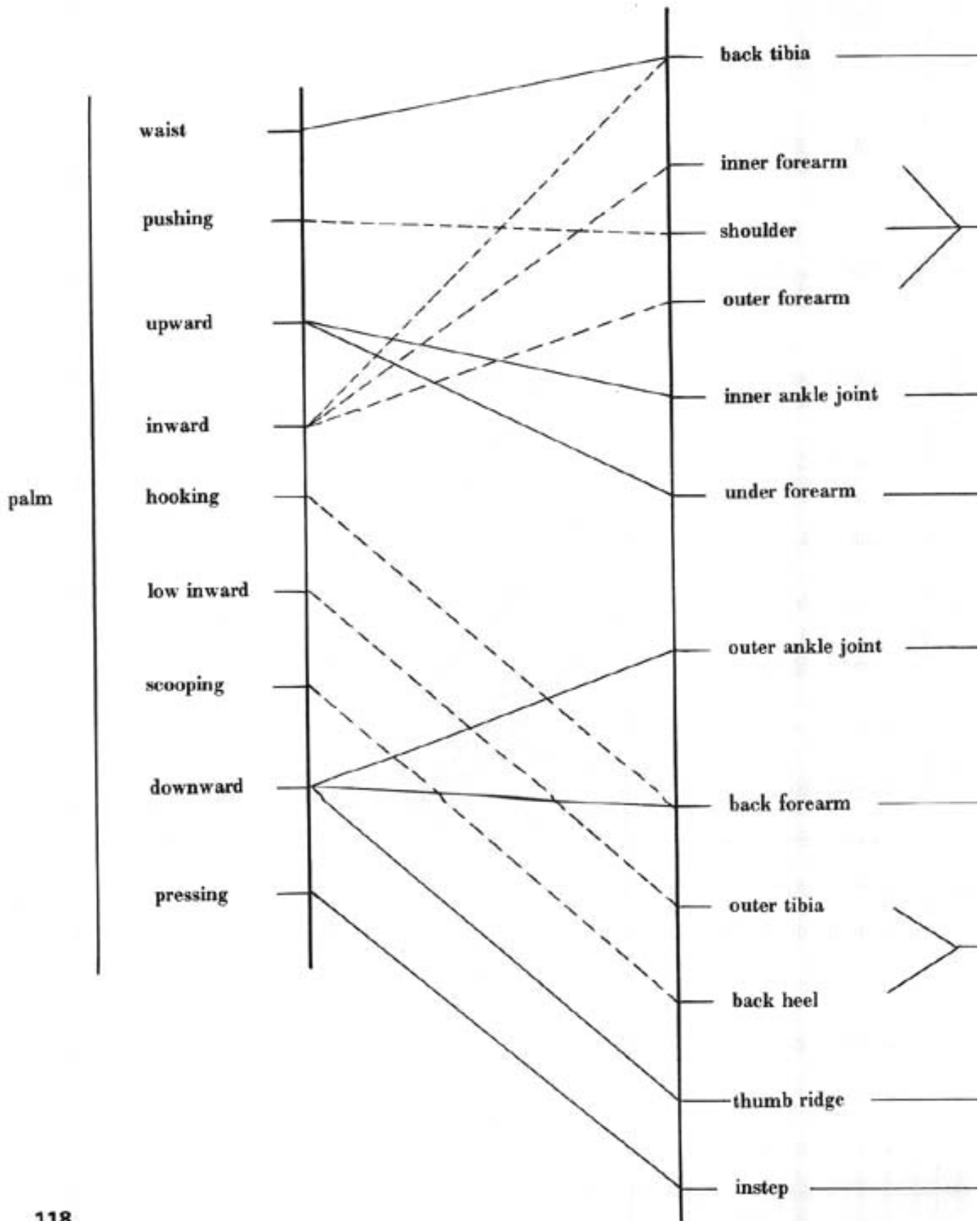

METHOD OF ATTACKING

ATTACKING TOOL

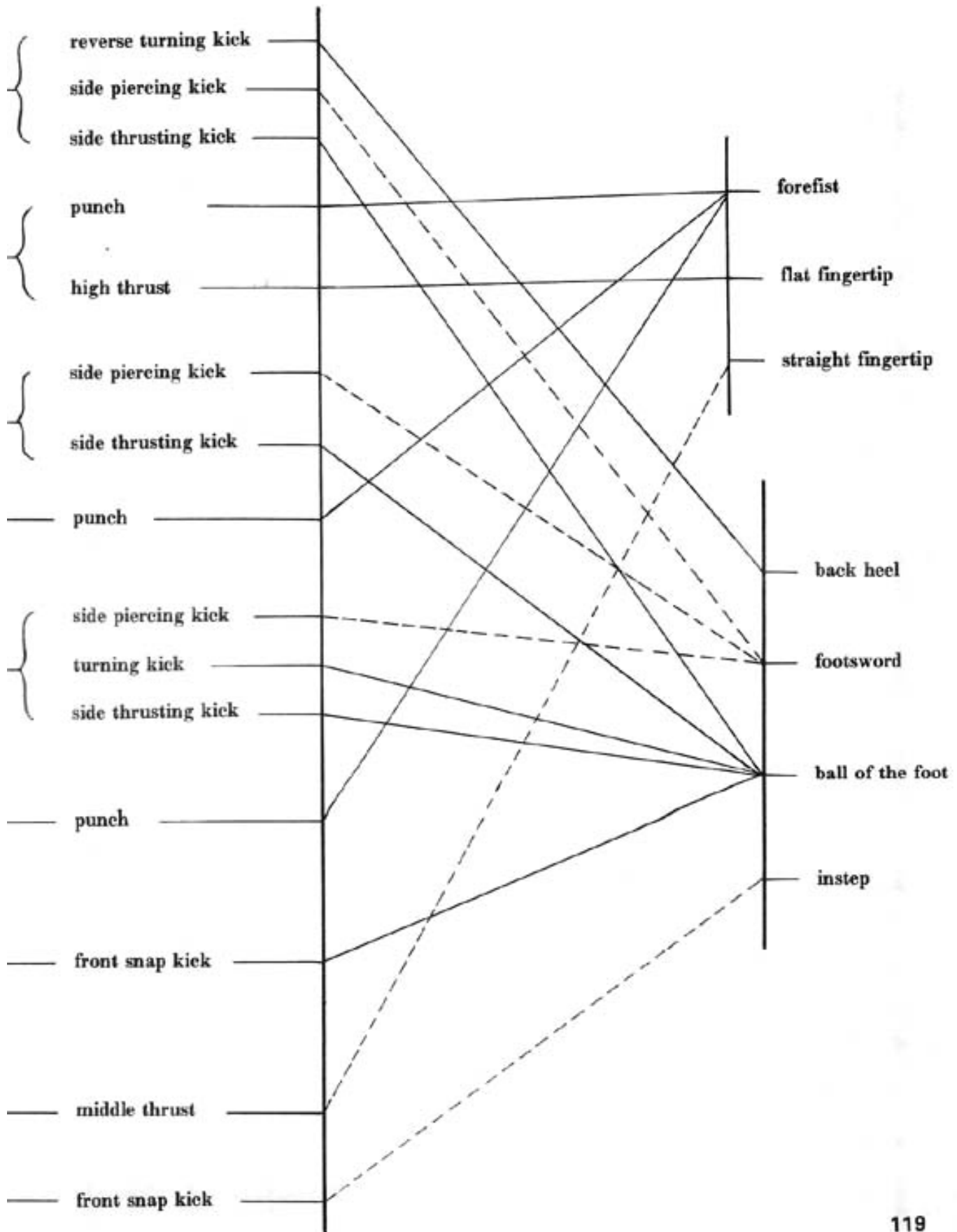

METHOD OF BLOCKING

PORTION BLOCKED

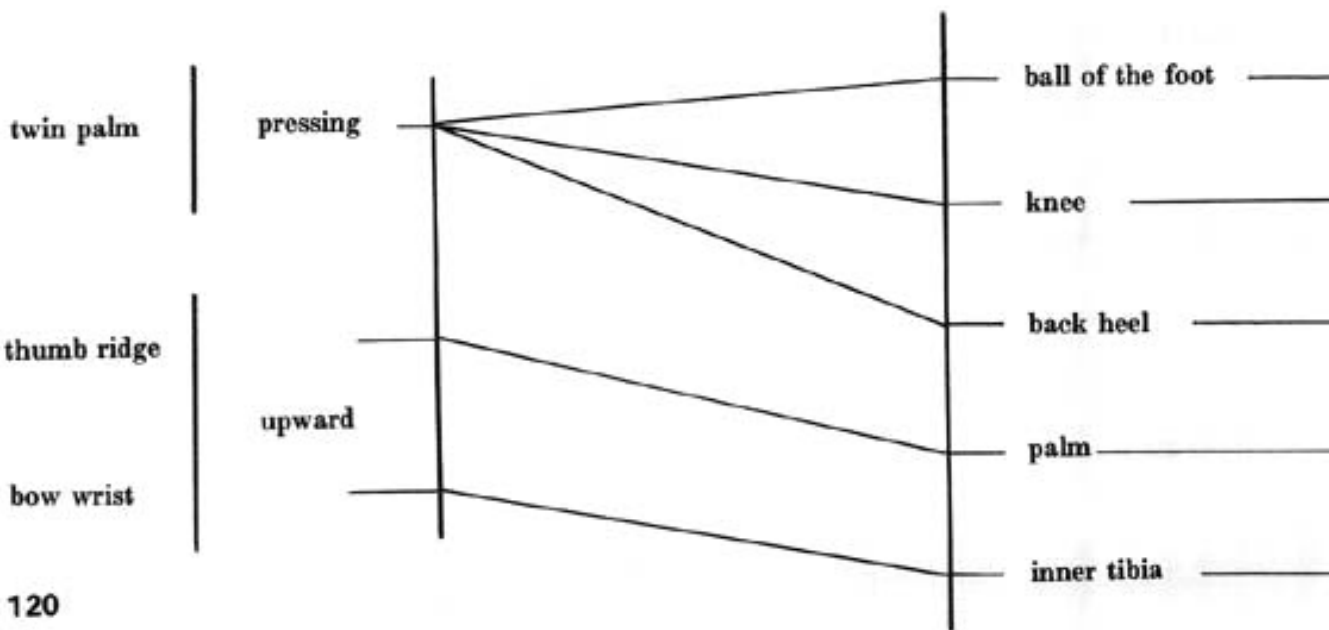
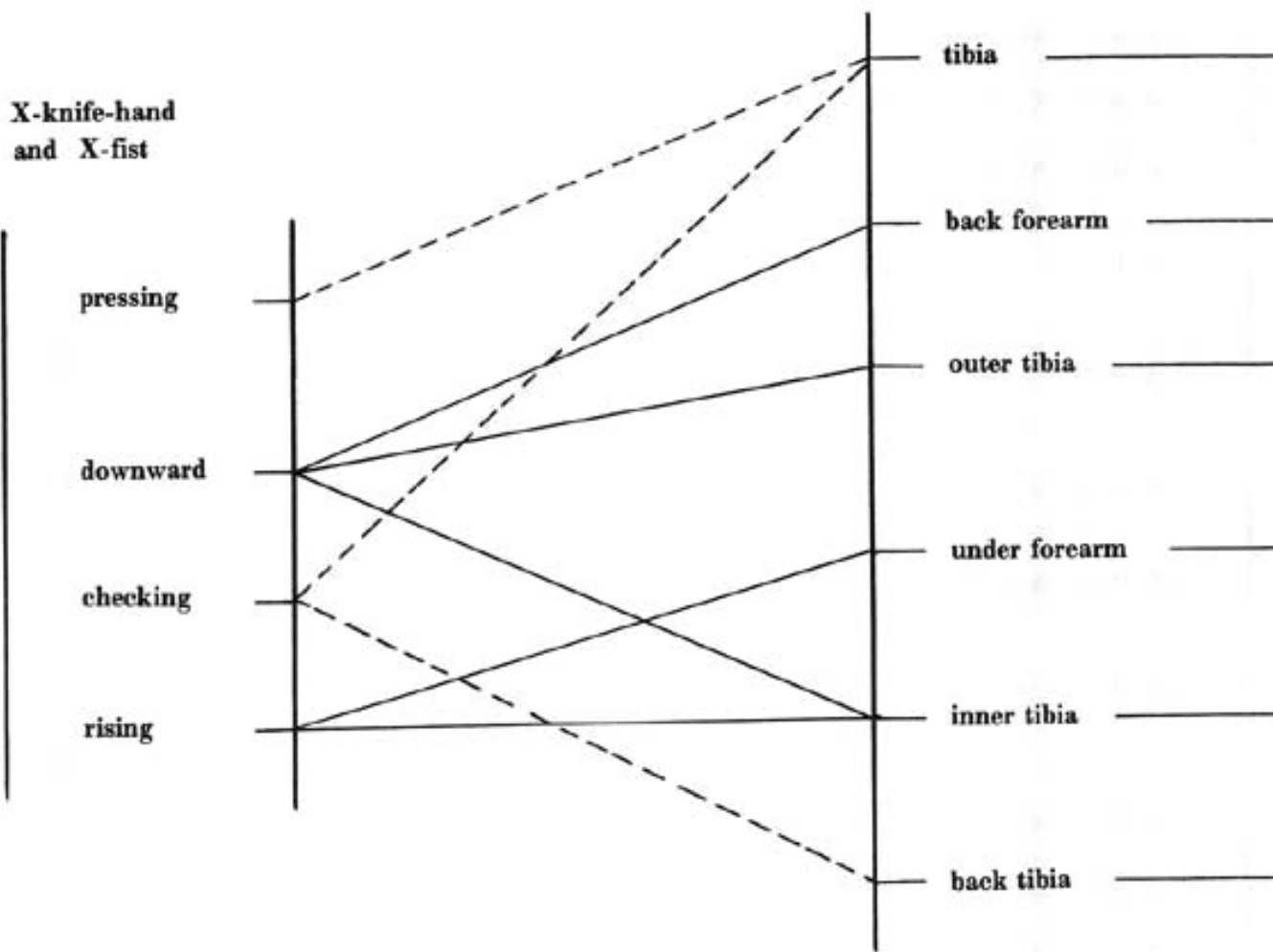

METHOD OF ATTACKING

ATTACKING TOOL

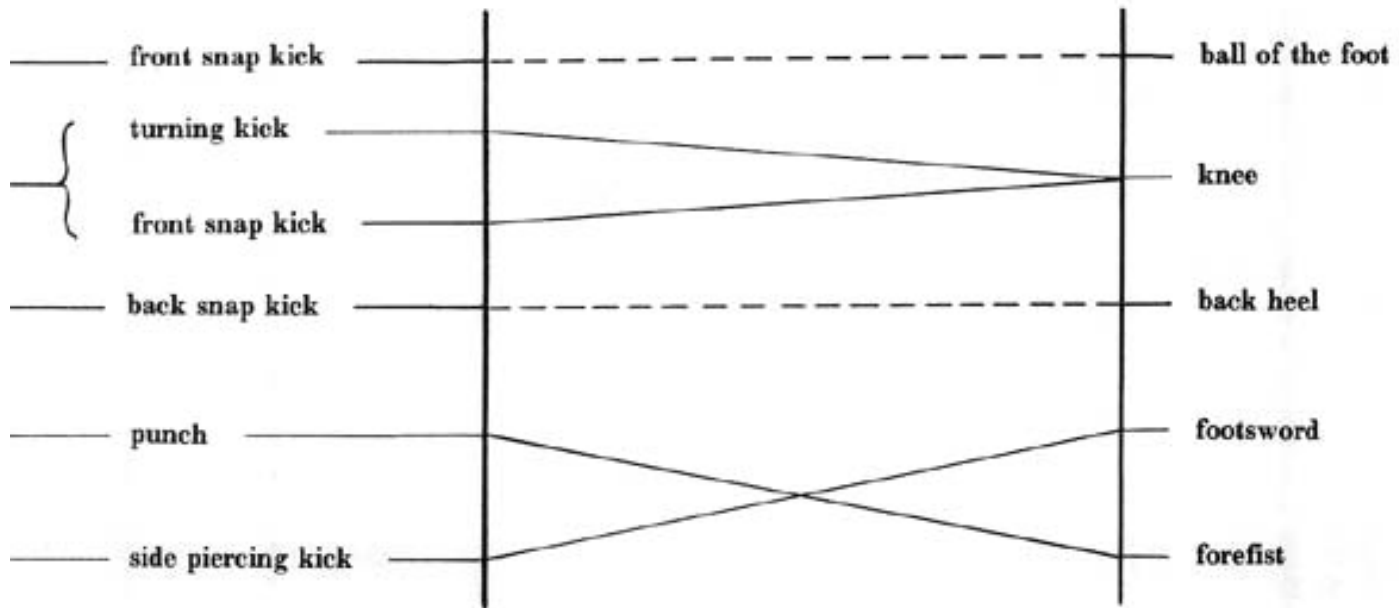
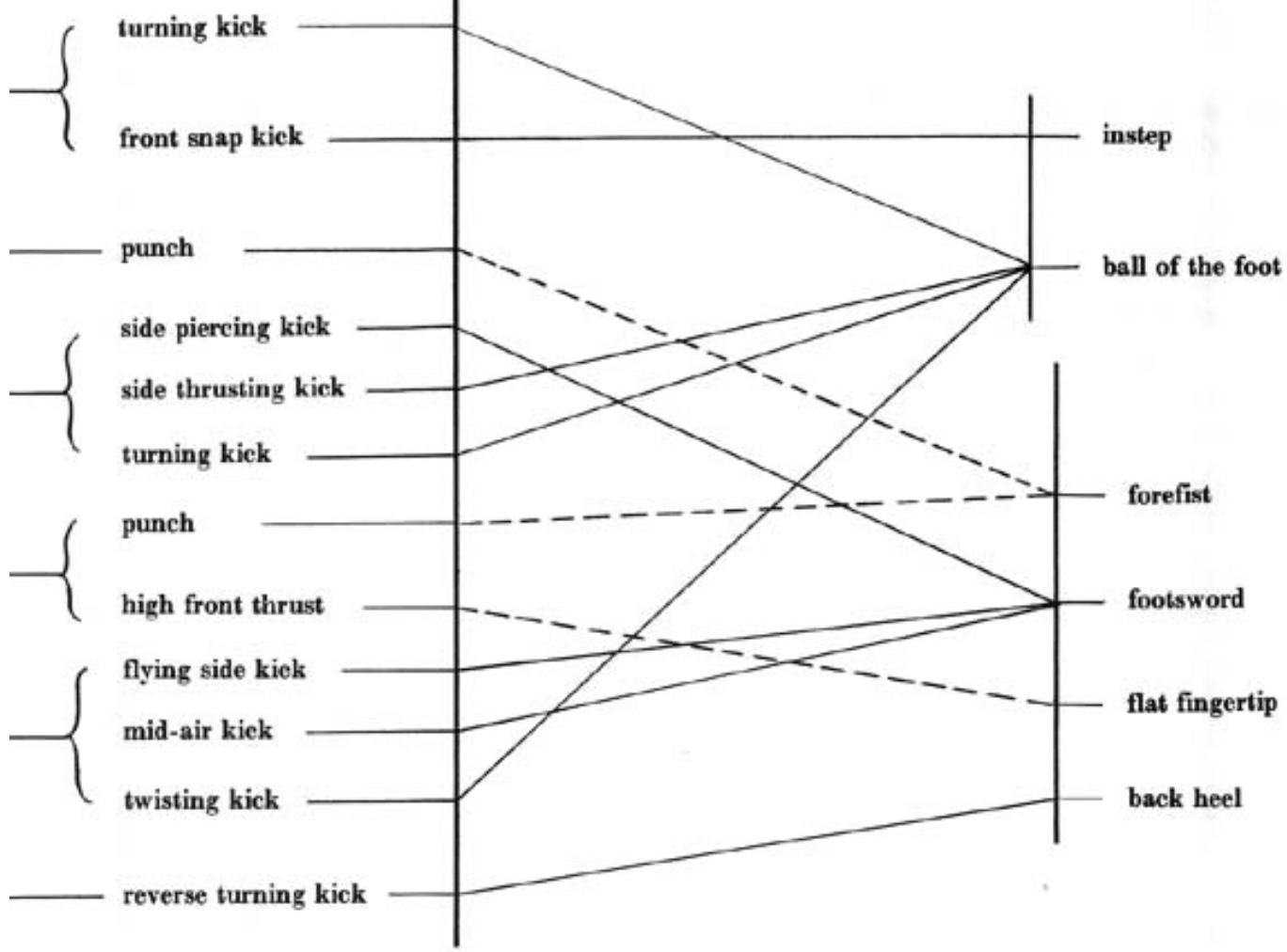

METHOD OF BLOCKING

PORTION BLOCKED

straight forearm and
straight knife-hand

checking

outer forearm

back tibia

outer tibia

inner tibia

inner forearm

double forearm

outward

pushing

outer forearm

inner forearm

tibia

back tibia

back forearm

under forearm

inner tibia

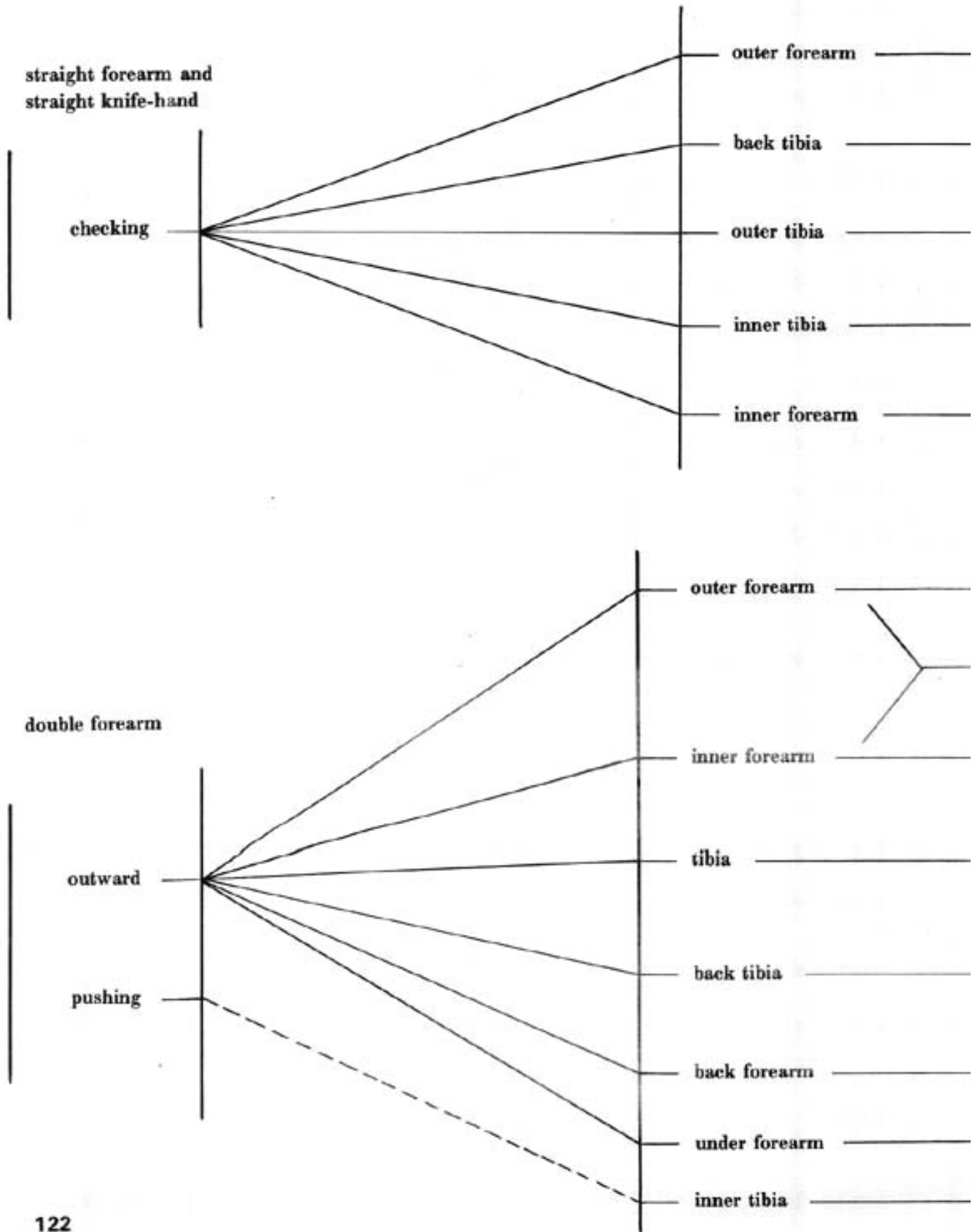

METHOD OF ATTACKING

ATTACKING TOOL

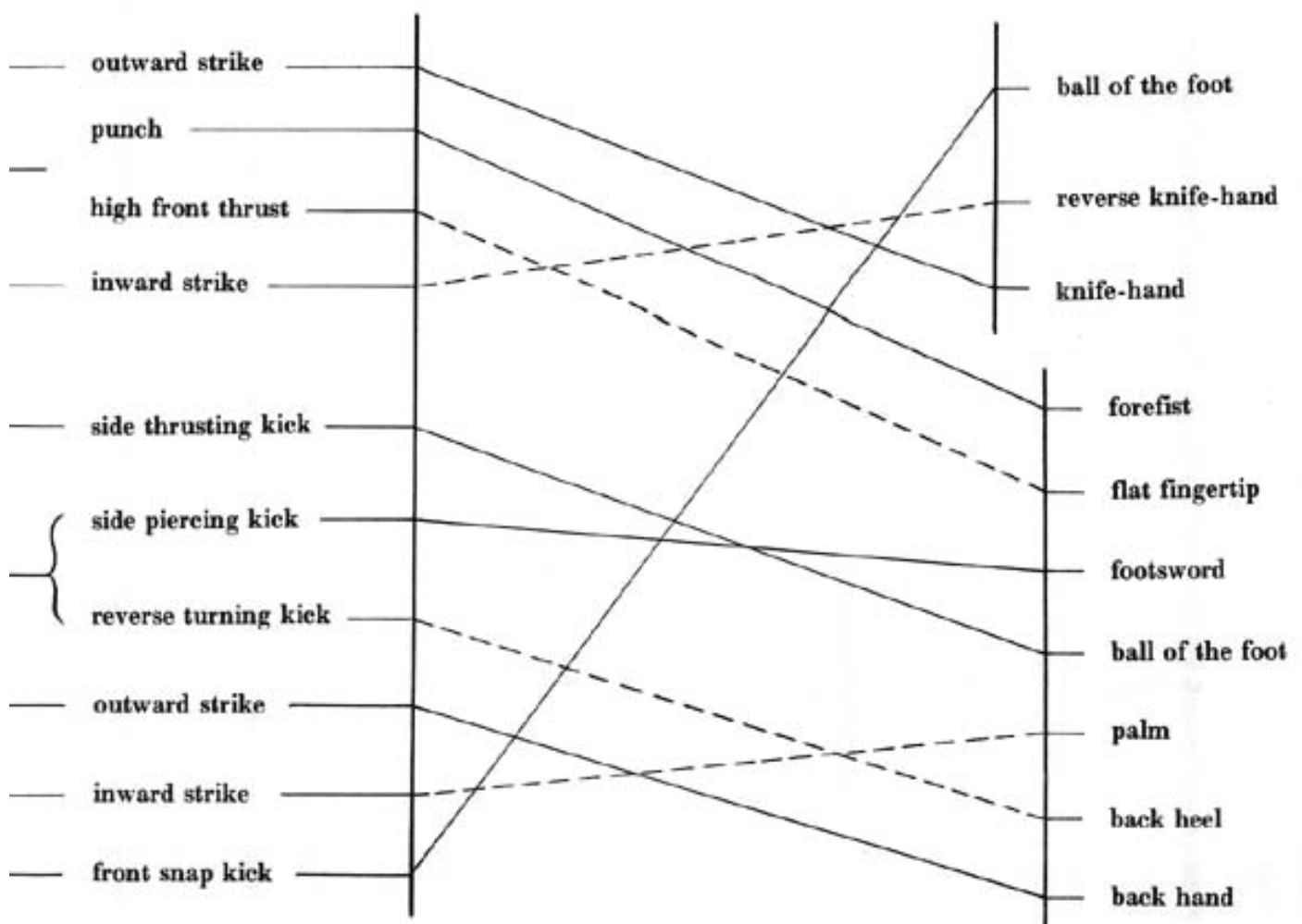
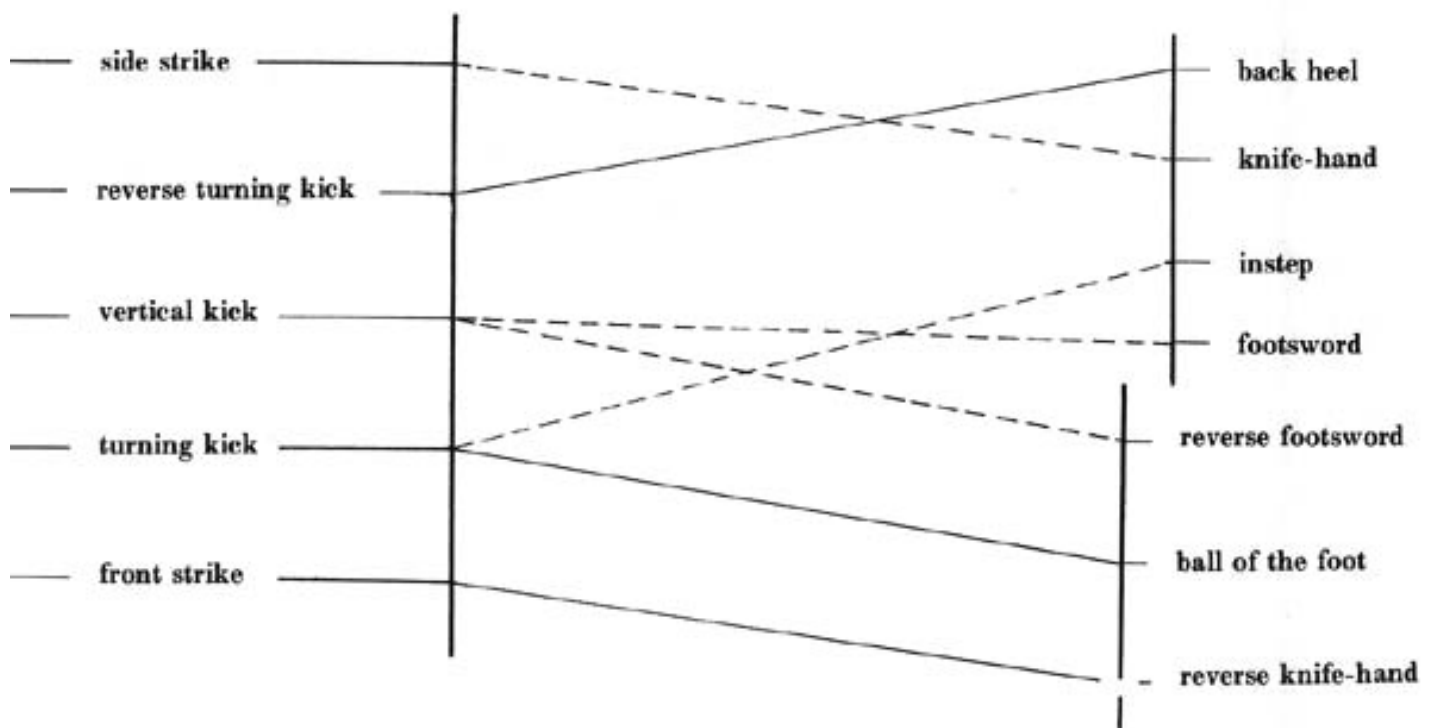

METHOD OF BLOCKING

PORTION BLOCKED

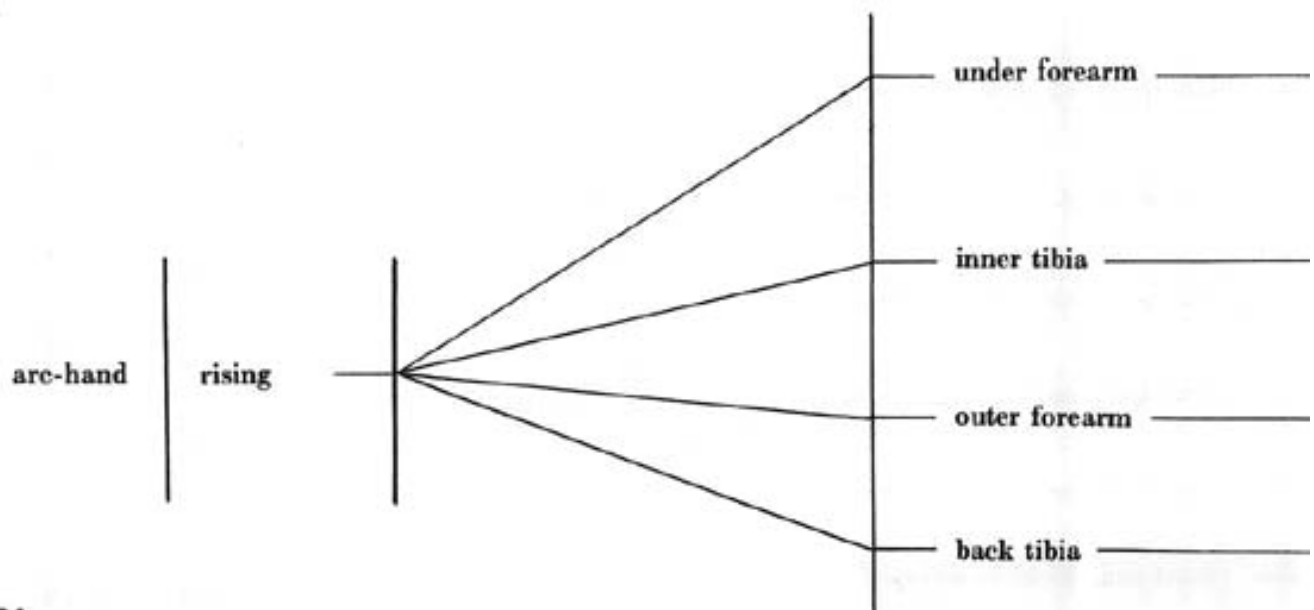
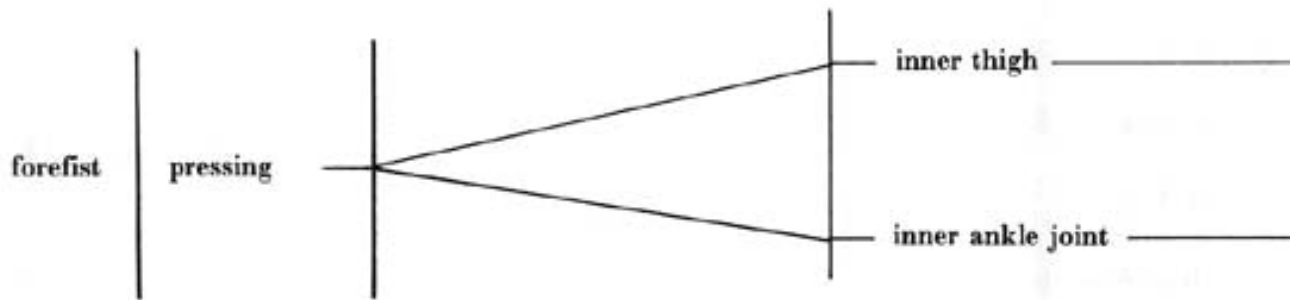
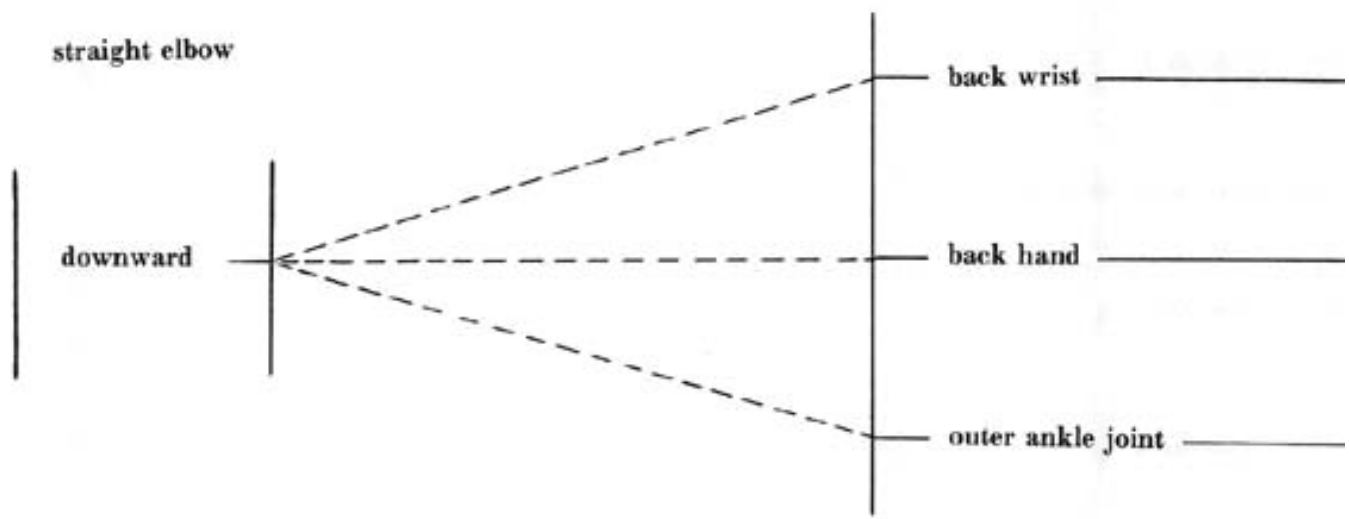

METHOD OF ATTACKING

ATTACKING TOOL

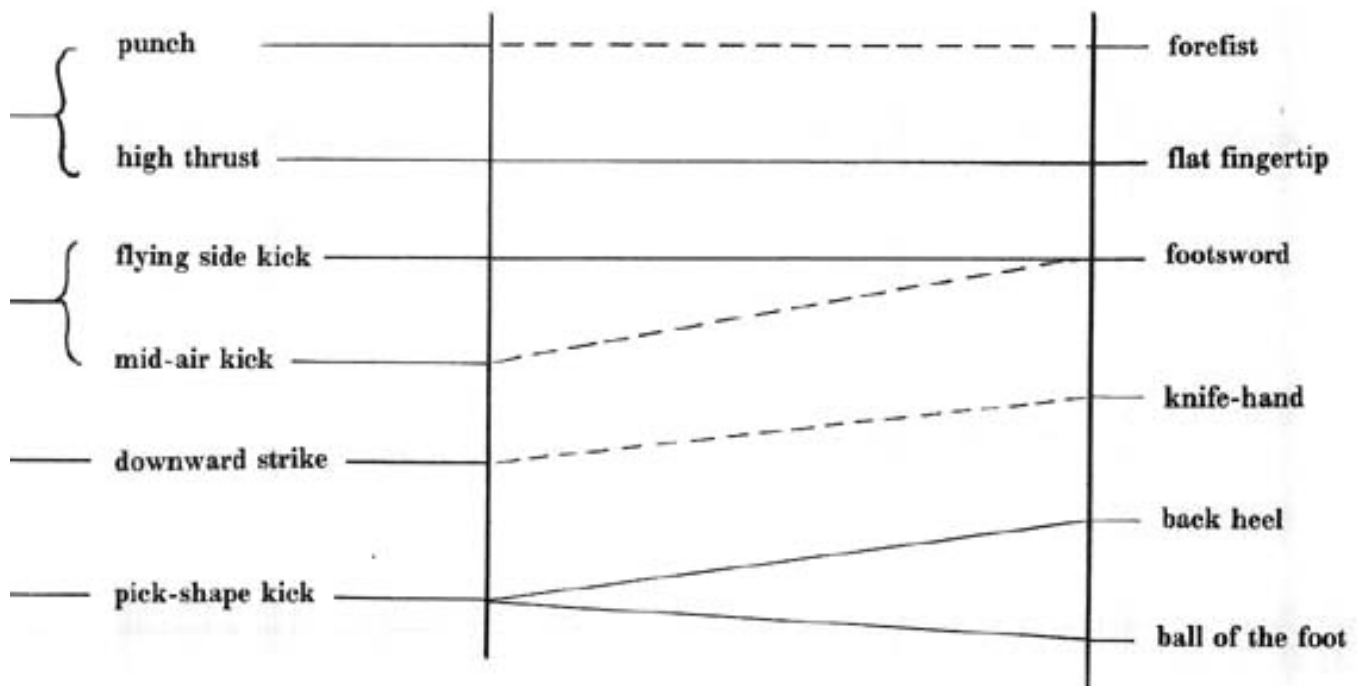
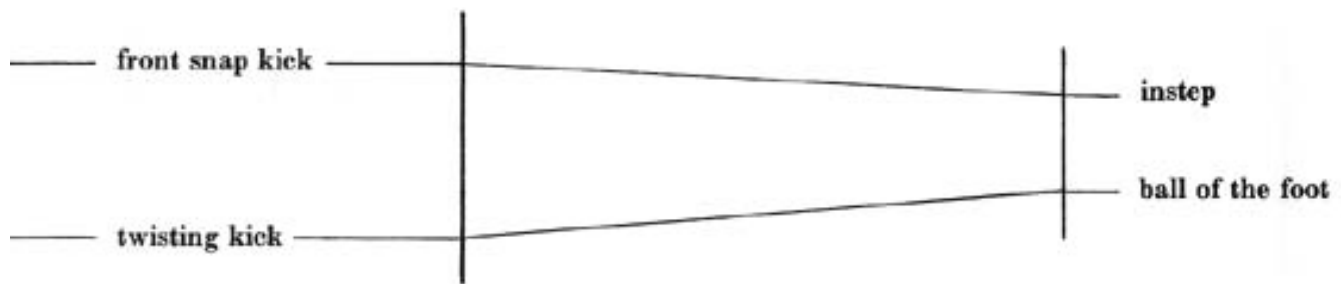
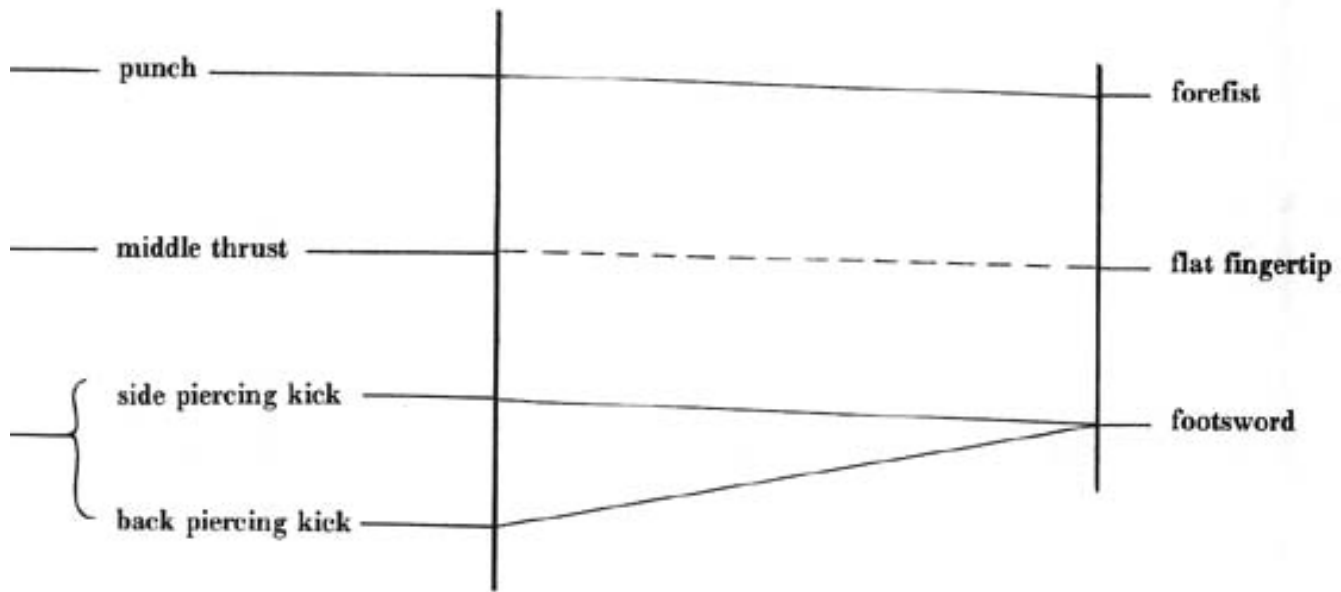

METHOD OF BLOCKING

PORTION BLOCKED

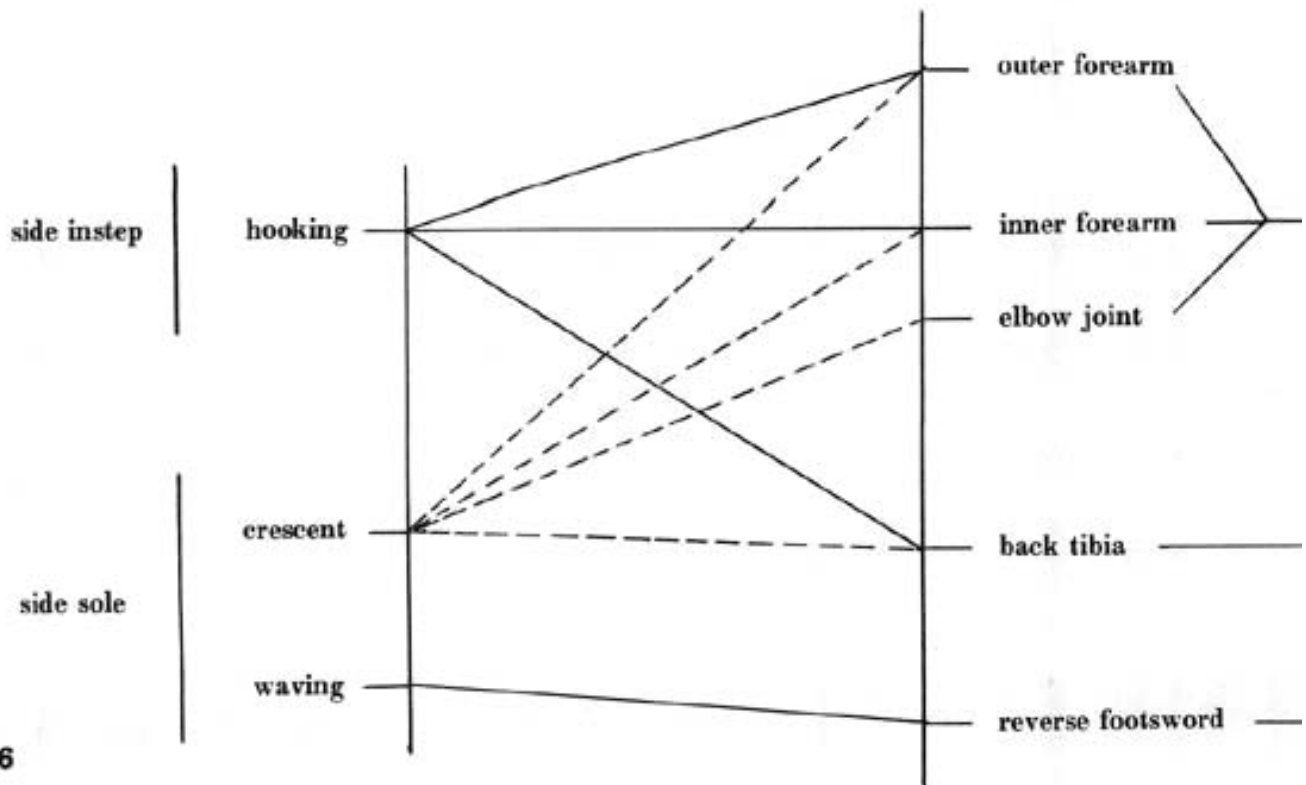
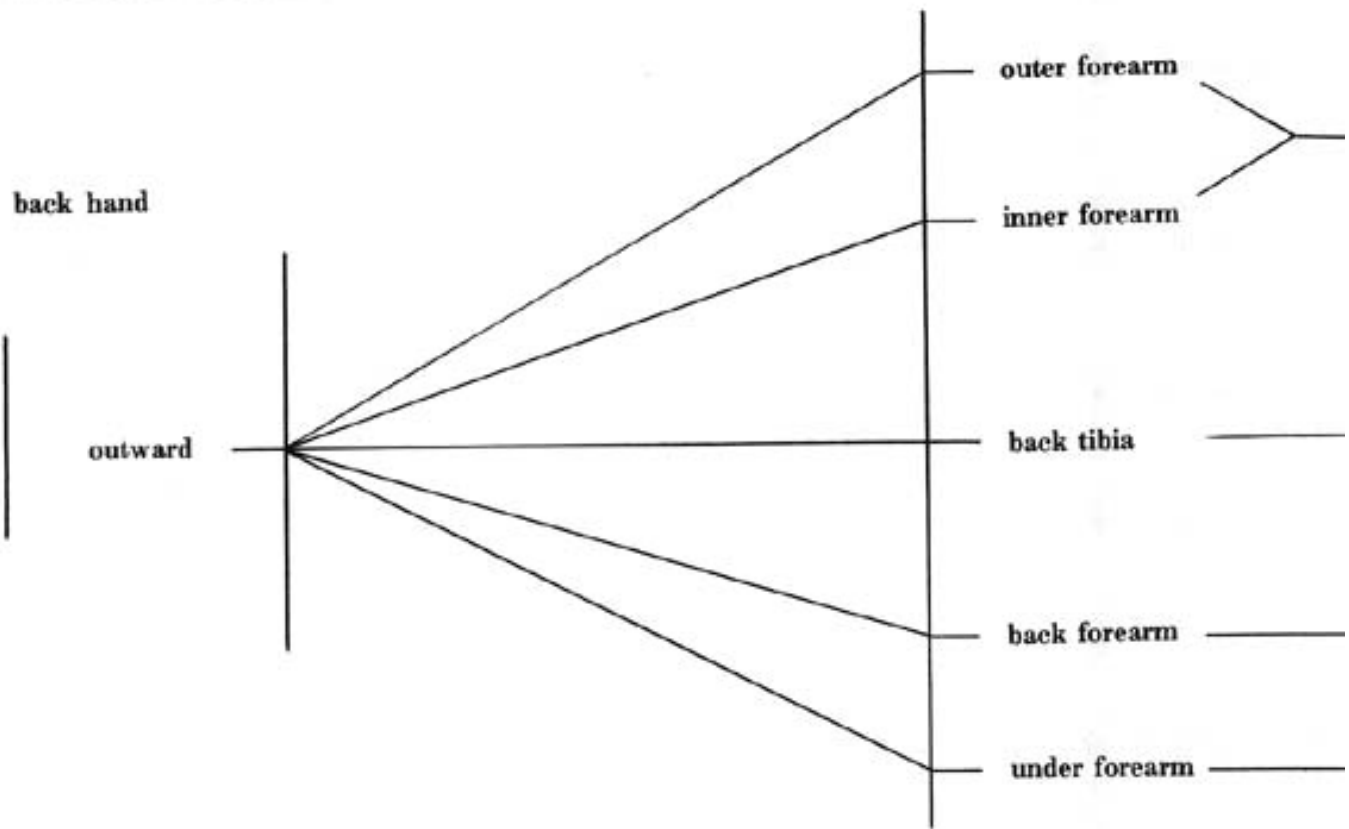

METHOD OF ATTACKING

ATTACKING TOOL

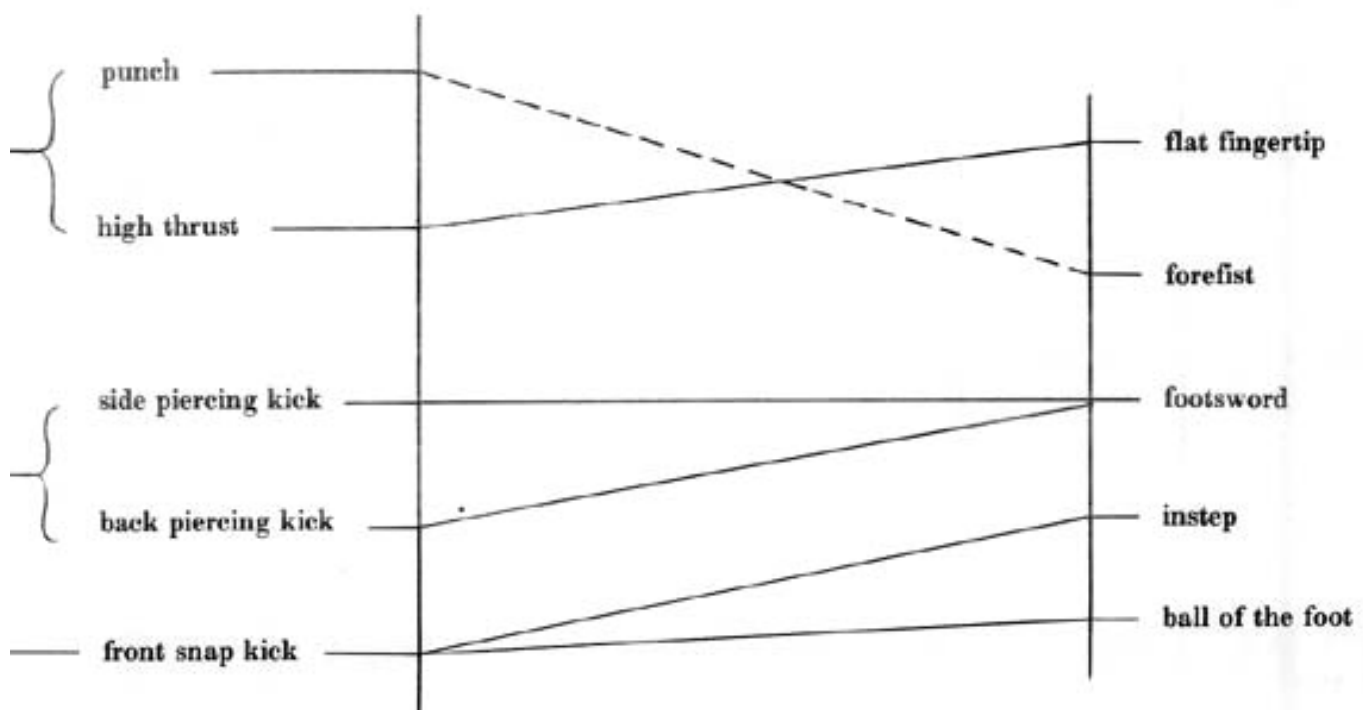
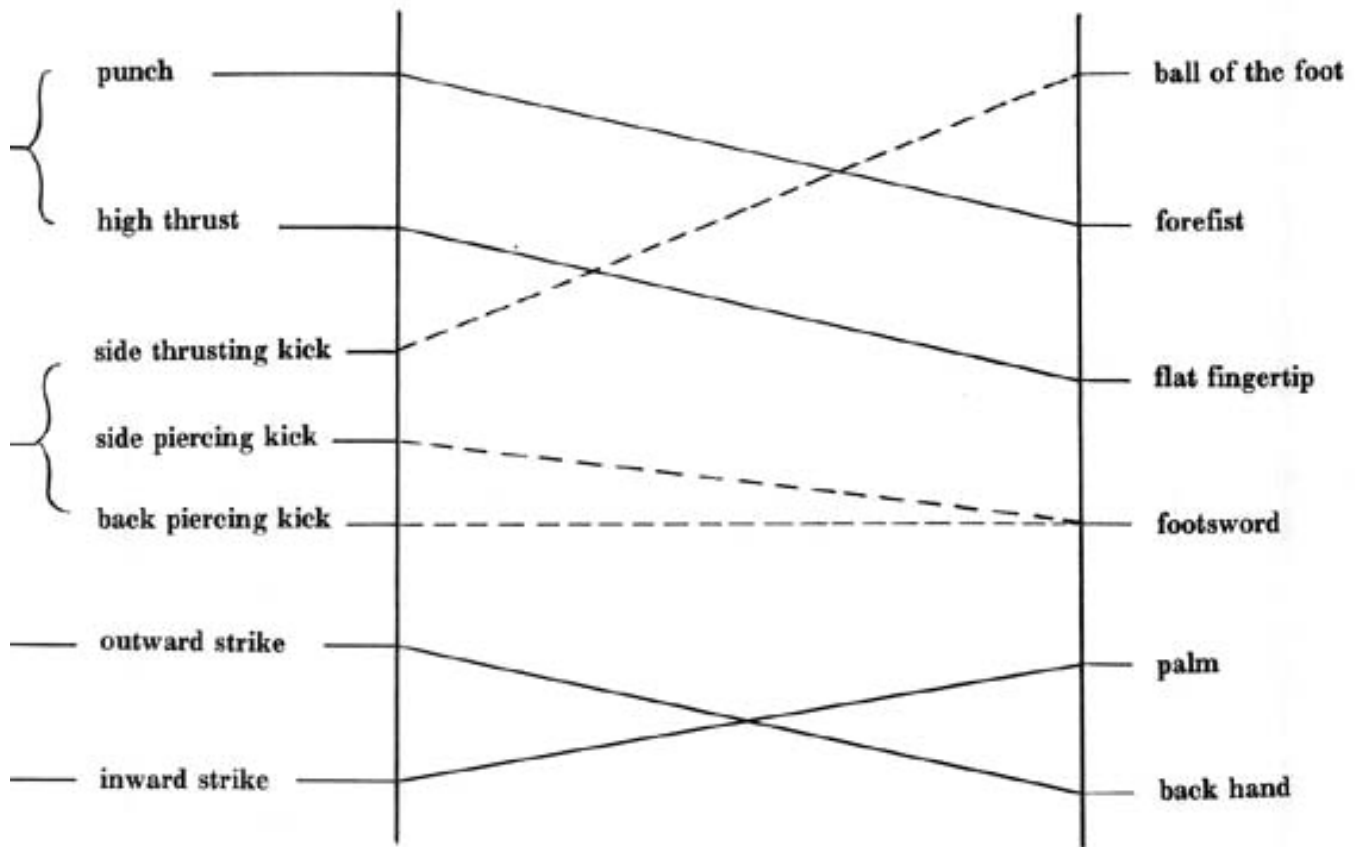

METHOD OF BLOCKING

PORTION BLOCKED

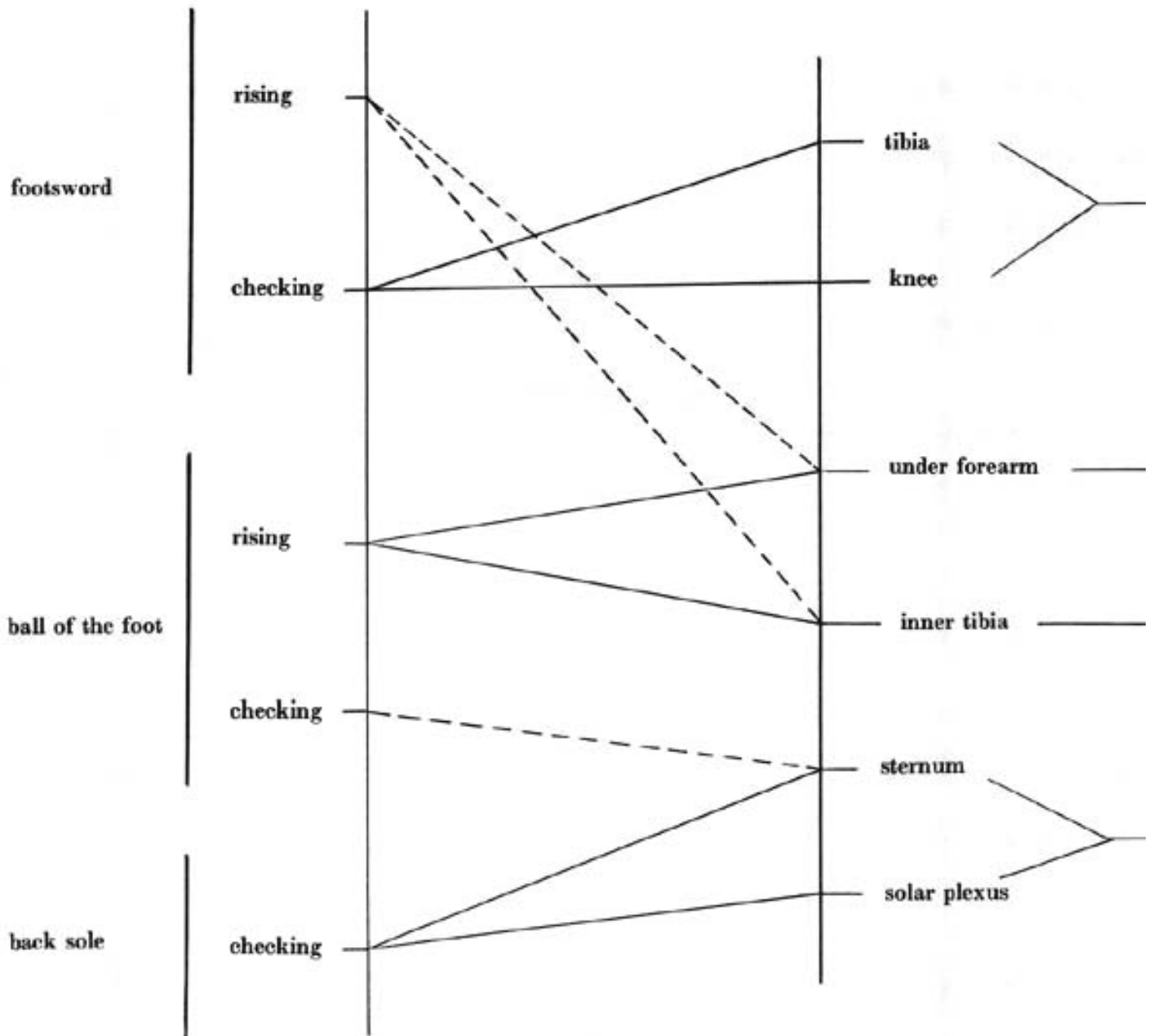

METHOD OF ATTACKING

ATTACKING TOOL

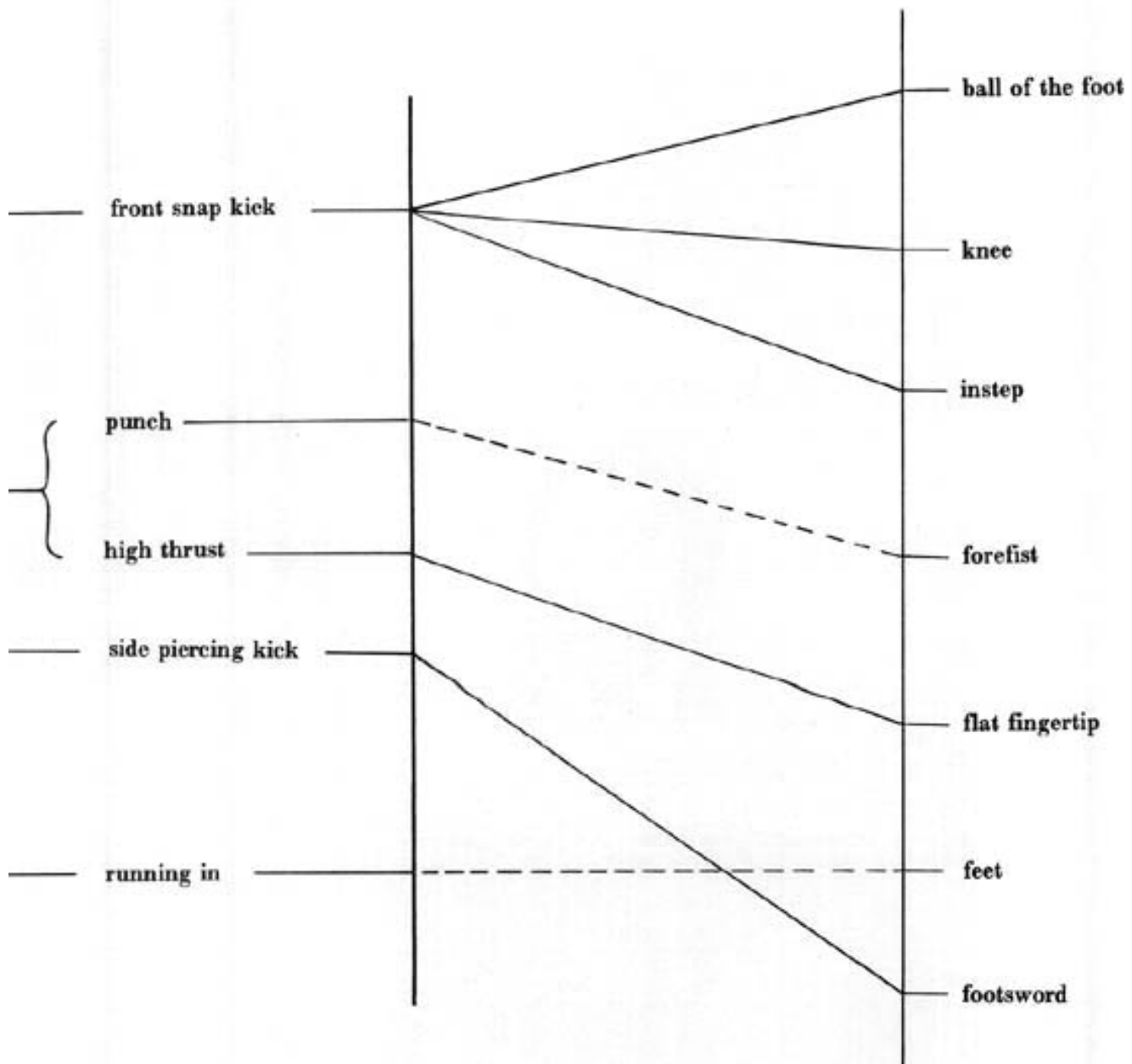

98-POUND WEAKLING, CONVERTED
Among Choi's portfolios,
he's Father of Taekwon-Do

Fundador Tae Kwon
Critica a Jhoon R

日八十月九年七七一 自創

崔泓熙开创跆拳道

—与刘观连总教练一席谈—



武林
專
訊

跆拳道(Taekwon-Do)是韩国人创造的。它是由跆拳道之父崔泓熙(Choi Hong-Hi)所创。崔泓熙在跆拳道的发展中起到了至关重要的作用。他不仅是一位杰出的武术家，还是一位教育家。他通过自己的努力，将跆拳道推广到了世界各地。跆拳道不仅是一种体育运动，更是一种生活哲学。它强调礼仪、尊重和自律。跆拳道已经成为全球最受欢迎的体育运动之一。崔泓熙的跆拳道理念深深影响了他的弟子们，他们将继续传承和发展跆拳道。

跆拳道(Taekwon-Do)是韩国人创造的。它是由跆拳道之父崔泓熙(Choi Hong-Hi)所创。崔泓熙在跆拳道的发展中起到了至关重要的作用。他不仅是一位杰出的武术家，还是一位教育家。他通过自己的努力，将跆拳道推广到了世界各地。跆拳道不仅是一种体育运动，更是一种生活哲学。它强调礼仪、尊重和自律。跆拳道已经成为全球最受欢迎的体育运动之一。崔泓熙的跆拳道理念深深影响了他的弟子们，他们将继续传承和发展跆拳道。



Founder of Taekwon-Do

Republic, Rockford, Ill., April 6, 1977

TaeKw
way of living for

By DOUG DARRINC
As a youngster in Korea in 1937, Hong-Hi Choi had a difficult childhood in support of the Korean independence struggle against Japanese occupation. He was exiled to Japan and jailed for a week.
NINE YEARS later, he was sent to a Japanese prison for Japanese soldiers, which he had been forced to join. The struggle was that he was planning to overthrow the Japanese military regime. He was jailed for a week and a half years in prison.
He later had a prison and in 1947, Choi said, "I don't like to study Japanese language and culture in prison, and always have been strongly anti-Japanese."
His dislike of the Japanese led Choi to develop one of the most popular martial arts. At the end of World War II, he returned to Korea, eventually gained the rank of lieutenant general in the Korean army, and taught his father's martial art, which everyone knows as Taekwon-Do. "I wanted to destroy the Japanese forces," Choi said.
SINCE ITS inception in the late 1940s, Taekwon-Do has become a



HONG-HI CHOI

when he returned to Korea. "I was a lieutenant general in the Korean army and taught my father's martial art, which everyone knows as Taekwon-Do," Choi said.



Gen. Choi Hong-Hi, Father of Taekwon-Do

Taekwon-Do leader links force, wisdom

An ancient Chinese proverb reads: "Without backing this way is the path of the hero." Gen. Choi Hong-Hi, a general in the Korean army (retired), visited the city to promote a Simon...
The impressive message conveyed by Choi can be summed up by his motto, discipline and heart of Taekwon-Do. He appears as a man fully confident of his skill set and at complete control of himself, physically and mentally.
He attributes many benefits to the discipline required of Taekwon-Do practitioners. "When you are a Taekwon-Do fighter, you are not only a warrior, but a man of peace," he said. "Many parents are happy to see their children taking in the art and they are proud to support Taekwon-Do." He also said it helps to overcome drug problems.
Another benefit is mental conditioning and weight reduction. The latter takes about six months of active training to bring about, he said. Choi also recommends Taekwon-Do to women.
The pretty ladies will be...
It is a pleasure to see a strong...
The pretty ladies will be...

TAE KWON-DO

The deadly art of a boy weakli

By Winston Song

A 31-year-old man yesterday revealed his childhood days and events leading to his becoming the world's No. 1 Tae kwon-do exponent.

He is Mr. Choi Hong Hi, a retired army major-general and former Korea Ambassador to Malaysia.

Now a full-time President of the world's Tae kwon-do body, Mr. Choi was born on Nov. 2, 1918 in the Ham Kyung Province of North Korea.

Forty-two years ago when he took up the Korean martial art of Taek Kyon, Mr. Choi never thought of ever becoming the emperor of the world — just the world's only 1st Dan Black Belt holder.

He recalled: "I was born very weak and my parents were worried about my health, so they encouraged me to take up an art of self-defense to protect myself."

"You I was trained in Taek Kyon when only 11-year-old, learning the fundamentals of Taek Kyon from Mr. Han H. Yang who was then the instructor at Chohan school."

He took an immediate interest in learning the art. At 16 he was very strong. He was the strongest in the 1st dan, 2nd dan and 3rd dan classes. But after a month, he became more and more ill.

He added: "After six years I had recovered from my early weakness."

When 18, Mr. Choi went to Japan to continue his

education at a modern Japanese school where he studied art and painting.

"But before my departure for Japan, he sadly recalled, "I had a quarrel with a friend after losing money in a card game."

"He refused to accept my plea for the return of the money which I received from my uncle for the trip. The incident resulted in a fight in which I managed to overpower my friend and recover the money."

When he arrived in Japan, he was told by a university instructor that the man whom he fought with wanted a fight.

He accepted. "From that time onwards, I decided to further my knowledge in martial art. For I had to have a blood feud before my return."

While studying in Japan for three years, I had no regular teacher as expert.

"Nevertheless, my strong desire to fight with the man I got blood feud with, drove me to the limit. I was then forced into military service during the Japanese Occupation and when he got some 100 soldiers, tried to recover his honor from them by the Japanese at last."

Mr. Choi went to Seoul in South Korea. The time was a big addition.

"I decided to learn a fighting strategy for my recovery," he said.

He continued: "Mr. Choi continued to study Tae Kyon in the mountains. He was trained by a private teacher, Choo Chong-pil, a soldier of a 1st military division to teach him the techniques of martial art."

"But to do so, I had to help him in his daily life."

Mr. Choi continued: "The martial art I studied was not the same as the Taek Kyon I had learned in Korea. It was a more powerful art, called Taekwon-do. It was a combination of the martial art of the Chinese and the martial art of the Japanese."

Mr. Choi continued: "I studied Taekwon-do in the mountains. I was trained by a private teacher, Choo Chong-pil, a soldier of a 1st military division to teach him the techniques of martial art."

"But to do so, I had to help him in his daily life."

Mr. Choi continued: "The martial art I studied was not the same as the Taek Kyon I had learned in Korea. It was a more powerful art, called Taekwon-do. It was a combination of the martial art of the Chinese and the martial art of the Japanese."

Mr. Choi continued: "I studied Taekwon-do in the mountains. I was trained by a private teacher, Choo Chong-pil, a soldier of a 1st military division to teach him the techniques of martial art."

"But to do so, I had to help him in his daily life."

Mr. Choi continued: "The martial art I studied was not the same as the Taek Kyon I had learned in Korea. It was a more powerful art, called Taekwon-do. It was a combination of the martial art of the Chinese and the martial art of the Japanese."

Mr. Choi continued: "I studied Taekwon-do in the mountains. I was trained by a private teacher, Choo Chong-pil, a soldier of a 1st military division to teach him the techniques of martial art."

"But to do so, I had to help him in his daily life."

Mr. Choi continued: "The martial art I studied was not the same as the Taek Kyon I had learned in Korea. It was a more powerful art, called Taekwon-do. It was a combination of the martial art of the Chinese and the martial art of the Japanese."



Mr. Choi Hong Hi, a 31-year-old man, is the world's No. 1 Tae kwon-do exponent. He was born on Nov. 2, 1918 in the Ham Kyung Province of North Korea. He studied martial art in Japan and Korea. He is now a full-time President of the world's Tae kwon-do body.

Choi's goal: Olympic Tae Kwon-Do

Mr. Choi said he was determined to bring Tae kwon-do to the Olympic Games. He is now working hard to get it recognized as an Olympic sport. He said he would like to see it included in the 1988 Olympic Games in Seoul.

Mr. Choi said he was determined to bring Tae kwon-do to the Olympic Games. He is now working hard to get it recognized as an Olympic sport. He said he would like to see it included in the 1988 Olympic Games in Seoul.

Mr. Choi said he was determined to bring Tae kwon-do to the Olympic Games. He is now working hard to get it recognized as an Olympic sport. He said he would like to see it included in the 1988 Olympic Games in Seoul.

Mr. Choi said he was determined to bring Tae kwon-do to the Olympic Games. He is now working hard to get it recognized as an Olympic sport. He said he would like to see it included in the 1988 Olympic Games in Seoul.

Mr. Choi said he was determined to bring Tae kwon-do to the Olympic Games. He is now working hard to get it recognized as an Olympic sport. He said he would like to see it included in the 1988 Olympic Games in Seoul.

Mr. Choi said he was determined to bring Tae kwon-do to the Olympic Games. He is now working hard to get it recognized as an Olympic sport. He said he would like to see it included in the 1988 Olympic Games in Seoul.



Choi's goal: Olympic Tae Kwon-Do. He is determined to bring this martial art to the Olympic Games.

Choi's goal: Olympic Tae Kwon-Do. He is determined to bring this martial art to the Olympic Games.



Choi's goal: Olympic Tae Kwon-Do. He is determined to bring this martial art to the Olympic Games.

趣味史話

三国時代

金剛力

金斗一対一

趣味史話 李福根

三国時代 金剛力 金斗一対一

IMPORTANT:

Due to the distortion of distance apparent in photographs, the angle of the feet in stances may appear slightly out of position. The student, therefore, is encouraged to refer to the feet illustrations rather than the photograph itself.

Parallel stance

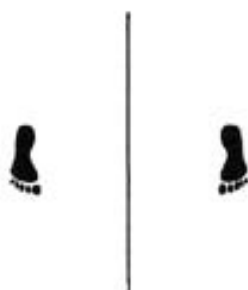

Sitting stance



Walking Stance (*Gunnun Sogi*)

Front view



Back View



L-Stance (*Niunja Sogi*)

Front View



Back View





STANCE (*Sogi*)

The forceful and finer techniques of attack and defence are largely dependent on a correct stance since the stance is the starting point of every Taekwon-Do movement.

Stability, agility, balance and flexibility are the controlling factors.

Basic principles for a proper stance are:

1. Keep the back straight, with few exceptions.
2. Relax the shoulders.
3. Tense the abdomen.
4. Maintain a correct facing. The stance may be full facing, half facing or side facing the opponent.
5. Maintain equilibrium.
6. Make use of the knee spring properly.

Side facing (*Chuk Myon*)



Side View

Close Stance (*Moa Sogi*)

Stand with the feet together. It can be either full facing or side facing.



Full facing (*Jon sin*)

Front View



Back View

Parallel Stance (*Narani Sogi*)

Spread the feet parallel to shoulder width. Keep the toes pointing toward the front. It can be either full facing or side facing.



Front View

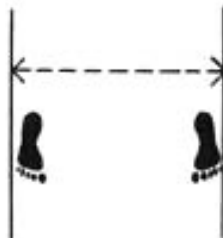

One shoulder width



Back View

Side View



Front View



INCORRECT

It is not only weak against an attack from the front or rear but hampers the beauty of the leg lines because the distance between the feet is over one shoulder width.

- * Knee spring refers to the function of the knee in raising and lowering the body.
- * Front foot refers to the foot which is advanced to the front. Rear foot refers to the foot which is placed at the rear.

Open Stance (*Palja Sogi*)

This stance is divided into outer open stance and inner open stance. It can be either full facing or side facing. Both of these are seldom used due to the looseness of the leg muscles and lack of stability.

Inner Open Stance (*An Palja Sogi*)

Keep the toes pointing slightly inward.



Front View

Side View



Outer Open Stance (*Bakat Palja Sogi*)

Keep the toes pointing outward about 45 degrees.



Front View

Side View



* These three stances serve primarily as preparatory actions though occasionally used for attack or defence.

Walking Stance (*Gunnun Sogi*)

This is a strong stance for front and rear, both in attack and defence.

1. Move one foot to either front or rear at a distance of one and a half shoulder width between the big toes and a shoulder width from one centre of the instep to the other. **Over** one and a half shoulder width in distance makes the movement slow and weak against an attack from the side, and weak against an attack from the front or rear.
2. Bend the front leg until the knee cap forms a vertical line with the heel, extending the opposite leg fully.
3. Distribute the body weight evenly on both feet.
4. Keep the toes of the front foot pointing forward, the opposite foot 25 degrees outward. **Over** 25 degrees weakens the leg joint against an attack from the rear.
5. Tense the muscles of the feet with the feeling of pulling them toward each other.

When the right leg is bent, the stance is called a right walking stance and vice-versa. It can be either full facing or half facing both in attack and defence.

Right walking stance
(*Orun gunnun Sogi*)



Centre of gravity

Left walking stance
(*Wen gunnun sogi*)

Side View



Front View

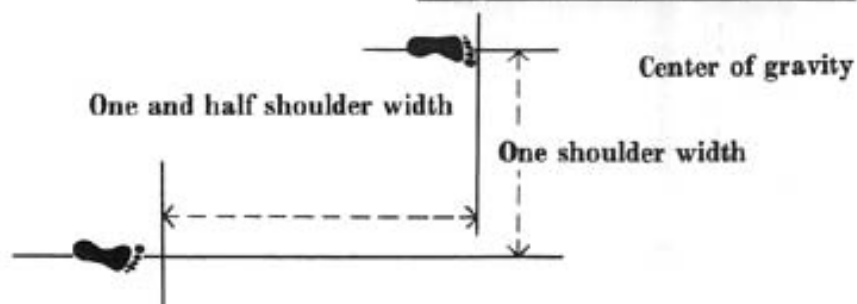



Full facing (*Jon sin*)



Half facing (*Ban sin*)



INCORRECT
The distance is too wide, making the movement slow and weak.



INCORRECT
The right heel is off the ground because the toes of the rear foot face forward.



INCORRECT
Not only does the movement, particularly a backward movement, become weak but also prohibits kicking with the front foot since the leg is bent excessively, which presents poor weight distribution.



INCORRECT
Weak against an attack from the side, since the width between the feet is too narrow.

INCORRECT
Weak against an attack from front or rear, since the distance between the feet is too wide.



INCORRECT
Leg joint is damaged because the toes of the rear foot are pointed outward over 25 degrees.

L-Stance (*Niunja Sogi*)

This is widely used for defense, though used in attack as well. The front foot is readily available for kicking with a slight shift of the body weight and with the advantage of half facing as well as body shifting.

1. Move one foot to either front or rear to a distance of approximately one and a half times the shoulder width from the footsword of the rear foot to the toes of the front foot, forming almost a right angle. It is recommended that the toes of both feet point about 15 degrees inward, placing the front heel beyond the heel of the rear foot about 2.5 centimeters to gain better stability.
2. Bend the rear leg until the knee cap forms a vertical line with the toes, bending the front leg proportionally.
3. Keep the hip aligned with the inner knee joint.
4. The ratio of the body weight is about 70 percent on the rear leg and 30 percent on the front leg.

When the right leg is bent it is called a right L-stance and vice-versa. It is always half facing, both for attack and defense.

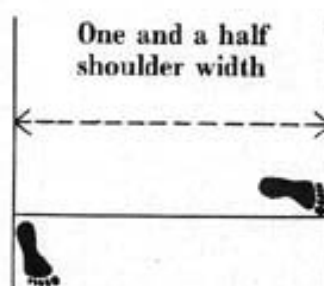

Right L-stance

Front View



Back View

Centre of gravity



INCORRECT

Damage is done to the left leg which is excessively bent.



INCORRECT

The front foot is placed too far inside making it susceptible to a foot sweep.



INCORRECT

The bottom is pushed too much to the rear thus failing to block effectively.



CORRECT

Jumping

Original posture has been recovered correctly.



INCORRECT

Jumping

Failed to recover the original posture.





INCORRECT

The opponent attacks before the defender has a chance to raise his foot since the stance is too wide.



INCORRECT

Toes are pointed outward.



The right knee is excessively bent.



Easily toppled.

Fixed Stance (*Gojung Sogi*)

It is an effective stance for attack and defense to the side. This stance is similar to the L-stance with the following exceptions:

1. The body weight is distributed on both legs evenly.
2. The distance between the feet is about one and a half shoulder width.

When the right foot is advanced, the stance is called a right fixed stance and vice-versa. It is always half facing, both in attack and defense.

Left fixed stance

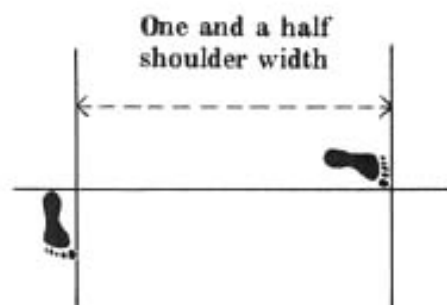

Front View



Right fixed stance

Right fixed stance



Side View

Right fixed stance



Back View



Right fixed stance

Side View



INCORRECT

The opponent attacks before the defender has a chance to raise her foot.

The punch is not as forceful as it should be.

INCORRECT

The right knee is pushed too far to the rear.



Sitting Stance (*Annun Sogi*)

This is a very stable stance for lateral movement. It is also widely used for punching exercise and muscle development of the legs. One of the advantages of this stance is to shift into walking stance without relocating the foot.

1. Spread one leg to the side at a distance of approximately one and half a shoulder width between the big toes.
2. Point the toes to the front and distribute the body weight evenly on both legs.
3. Extend the knees outward, bending until the knee caps come over the ball of the foot.
4. Infuse the strength into the inner thighs and tense inward by scraping the ground or floor with the side soles.
5. Push both the chest and abdomen out and pull the hip back tensing the abdomen.

Double width of the shoulder weakens the stance and speedy movement is hampered. It is either full facing or side facing, both in attack and defence.

Full facing



Front View

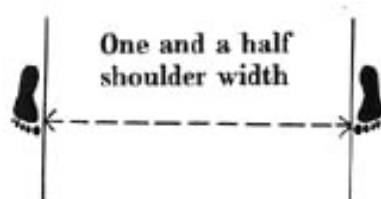

Side facing



Side View

INCORRECT
The hip is over extended.



INCORRECT
The stance is too wide.



Not only side movement is hampered but the opponent is attacked even before being able to raise the left foot.

INCORRECT
The abdomen is thrown out too far.



The punch is not powerful.



INCORRECT
Toes are pointed outward.



INCORRECT
The knees are bent inward.



INCORRECT
The knees are excessively bent.

Diagonal Stance (*Sasun sogi*)

This is very useful for shifting into a walking stance without relocating the foot. The principle for a sitting stance is directly applied except that the heel of the front foot is placed on the same line with the toes of the rear foot. It is used for attacking and defending against the front or rear. When the right foot is advanced, the stance is called a right diagonal stance and vice-versa. It can be either full facing or side facing both in attack and defense.

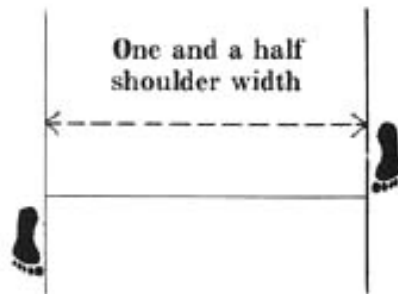

Right diagonal stance



Front View

Right diagonal stance



Side View

Left diagonal stance



Side View

Crouched Stance (*Oguryo Sogi*)

This is a variation of the diagonal stance and makes use of leg tension by bending the knees inward. Although this stance provides some advantages for shifting into other stances quickly and presents flexible guarding posture to make the opponent move in free sparring, it is not used widely due to the weakness of the knee joints against attack from the sides. The distance between the feet can be flexible. When the right foot is advanced, it is called a right crouched stance and vice-versa. It can be either full facing or side facing both in attack and defense.



Front View

Left crouched stance



Right crouched stance



Back View

Right crouched stance



Side View



Right X-stance



Side View

Front View



X-Stance (*Kyocho Sogi*)

This is a very convenient stance for attacking the side or front. It is occasionally used for blocking and serves as a preparatory stance for moving into the next maneuver.

1. Cross one foot over or behind the other, touching the ground slightly with the ball of the foot.
2. Place the body weight on the stationary foot.

When the weight is rested on the right foot, the stance is called a right X-stance and vice-versa. The other foot is usually placed in front of the stationary foot. It is either full facing or half facing, both in attack and defense.

Right X-stance



Back View

Left X-stance



Front View

Left X- stance



Side View

One-Leg Stance (*Waebal Sogi*)

Though this stance is primarily used for balance exercise, it is occasionally utilized in attack and defense techniques. Stretch the stationary leg and bring the other reverse footsword on the knee joint or instep to the hollow. When standing with the right foot, it is called a right one-leg stance and vice-versa. It can be either full facing or side facing, both in attack and defense.



Left one-leg stance



Right one-leg stance



Side View



Side View

Right one-leg stance



Back View

Left one-leg stance

Left bending stance

Bending Stance (*Guburyo Sogi*)

This serves as a preparatory stance for side and back kicks, though it is frequently used for defense techniques. When standing with a right foot it is called a right bending stance and vice-versa. It is either full facing or half facing.



Right bending stance

Side View



Side View



Front View

Vertical Stance (*Soojik Sogi*)

1. Move one foot to either front or side at a distance of one shoulder width between the big toes.
2. The ratio of body weight is 60 percent on the rear leg and 40 percent on the front leg.
3. Keep the toes of both feet pointed approximately 15 degrees inward.
4. Keep the legs straight.

When the right foot is in the rear, the stance is called a right vertical stance and vice-versa. It is always half facing, both in attack and defense.

Left vertical stance



Front View

Right vertical stance



Side View

Front View



Right vertical stance

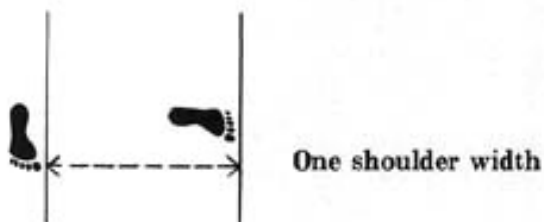

Rear Foot Stance (*Dwitbal Sogi*)

This is used for defense and occasionally for attack. The advantage of this stance is the ability to kick or adjust the distance from an opponent with the front foot which can move spontaneously without any additional shifting of the body weight to the rear foot.

1. Move one foot to either the front or the rear at a distance of one shoulder width between the small toes.
2. Bend the rear leg until the knee comes over the toes, placing the heel slightly beyond the heel of the front foot.
3. Bend the front leg, touching the ground slightly with the ball of the foot.
4. Keep the toes of front foot pointing about 25 degrees and the toes of the rear foot about 15 degrees inward.
5. Distribute most of the body weight on the rear foot.

When the right foot is in the rear, the stance is called a right rear foot stance and vice-versa. It is always half facing, both in attack and defense. Be sure to keep the knee of the rear leg pointing slightly inward.

Right rear foot stance



Front View



Side View

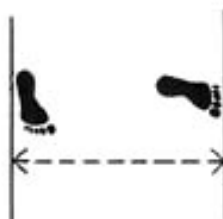

One shoulder width

Left rear foot stance



Side View

Left rear foot stance



Front View

Right rear foot stance



Back View

INCORRECT
The right knee points outward
instead of inward.



Low Stance (*Nachuo Sogi*)

The advantage of this stance is the ease with which one can extend the attacking tool. It can also develop the leg muscles and is effective to adjust the distance to and from the target. It is similar to the walking stance, though longer by one foot. It can be either full facing or side facing.



Front View



Front View

Right low stance

Left low stance

Right low stance

Left low stance



Side View



Side View

READY STANCE (*Junbi Sogi*)

Though there are many ready stances; parallel, open, close and bending ready stances are exclusively used in the fundamental and pattern exercises. The ready stance is not a direct part of any action. It merely positions a student before he begins his motions or allows time for concentration of spirit.



Front View

Attention Stance (*Charyot Sogi*)

This is an attention position used before and after class.

1. Feet form a 45 degrees angle.
2. Drop the fists down naturally, bending the elbows slightly.
3. The fists are clenched slightly.
4. Eyes face the front slightly above the horizontal line.

Bow Posture (*Kyong Ye Jase*)

1. Bend the body 15 degrees forward.
2. Keep eyes fixed on opponent's eyes.

CORRECT



INCORRET



Parallel Ready Stance (*Narani Junbi Sogi*)

This is just a parallel stance with both fists brought naturally over the abdomen.

1. The distance between fists is about five centimeters and seven centimeters away from the abdomen.
2. The distance between the elbows and the floating ribs is about 10 centimeters.
3. Do not extend the elbow to the side more than necessary.
4. Hold the upper arms forward 30 degrees while bending the forearms 40 degrees upward.



Front View



Side View

Back view



INCORRECT
Shoulders are tensed.

Open Ready Stance (*Palja Junbi Sogi*)

This is nothing but an open stance with both fists brought naturally over the thighs.

This stance, however, is seldom used due to the looseness of the body and muscles.



Front View

Outer Open Ready Stance

Inner Open Ready Stance



Side View

Sitting Ready Stance (*Annun Junbi Sogi*)

This is primarily used for side stepping exercise. The position of the hands is the same as in a walking ready stance.



Front View



Side View

Close Ready Stance (*Moa Junbi Sogi*)

It is classified generally into types A,B and C.

Type A

The distance between the philtrum and the fists is about 30 centimeters.



Front View



Side View

Type B

The distance between the fists and the navel is about 15 centimeters.



Front View



Side View

Type C

The distance between the hands and the abdomen is about 10 centimeters.



Front View

Side View



Walking Ready Stance (*Gunnun Junbi Sogi*)

1. The distance between the fists and thigh is about 30 centimeters.
2. The elbow should be bent 30 degrees.

Left walking ready stance



Front View

Right walking ready stance

Side View



Bending Ready Stance (*Guburyo Junbi Sogi*)

It is classified into type A and B. When standing with a right foot executing a left forearm guarding block, it is called a right bending ready stance and vice-versa.

Type A

It is principally used for a preparatory position of side piercing and side thrusting kicks.

Right bending ready stance A



Front View

Left bending ready stance A



Side View

Right bending ready stance A



Back View

Left bending ready stance A



Side View

Type B

It is a preparatory position of back piercing kick.

1. The distance between the fists and thigh is about 25 centimeters.
2. The elbow should be bent 30 degrees.

Right bending ready stance B



Front View

Left bending ready stance B



Front View

Left bending ready stance B



Side View

Left bending ready stance B



Back View

L-Ready Stance (*Niunja Junbi Sogi*)



Front View



Side View

X-Ready Stance (*Kyocha Junbi Sogi*)



Front view



Back View

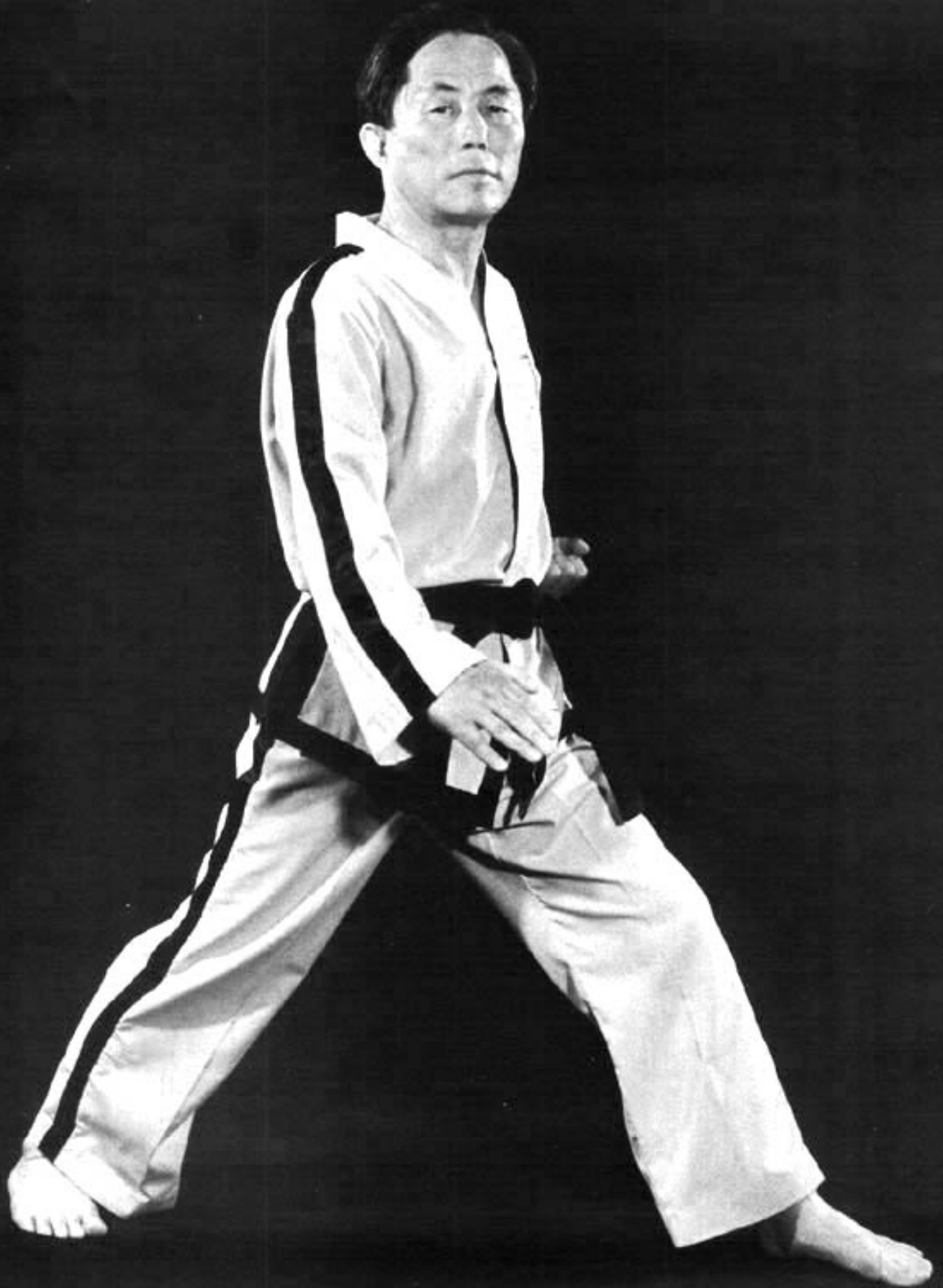

TRAINING (*Sooryon*)

Taekwon-Do training can be conducted in any physical location even with the absence of training aids. This is perhaps one of the greatest advantages of this art.

In order, however, to obtain the optimum results of training, regular equipment and a training hall are required.



Below is the desired standard for a do jang:

1. Size: 15 meters by 14 meters is an ideal size for 40 students per session.
2. Floor: It should be a wooden floor which has the resilience to prevent injury during training.
3. Name plate: It shows both the name and rank of each student, promoting incentive.
4. Training aids: Must be adequate and adhere to standards.
5. Lockers
6. Shower and sauna (Optional)
7. Sanitation facilities
8. Emergency facilities
9. The student oath below plainly displayed:
 - a. I shall observe the tenets of Taekwon-Do.
 - b. I shall respect the instructor and seniors.
 - c. I shall never misuse Taekwon-Do.
 - d. I shall be a champion of freedom and justice.
 - e. I shall build a more peaceful world.
10. International Taekwon-Do Federation flag and other Taekwon-Do insignias (up to instructor's discretion): to promote respect for true Taekwon-Do.
11. Recognition plaque: To identify an authorized school of the International Taekwon-Do Federation.

TRAINING HALL (*Do Jang*)

A do jang is an area where young and old, men and women, regardless of race or creed, come to learn Taekwon-Do for the promotion of their mental, moral, physical and cultural education. It should be a place where a certain "esprit de corps" between members can be established with a common goal of promoting and cultivating a noble character. Certainly, to fill the prerequisites necessary to attain these ideas, a well-trained—mentally and physically—black belt instructor is needed. This is the primary consideration for any do jang. The hall itself must also have the facilities, equipment, and strict regulations to help discipline the student's mind and body.

The size of the do jang and equipment to be used can be flexible according to the circumstances and individual choice. Again, the only thing that cannot be compromised is the quality of the instructor.



Do Jang Regulations:

1. Smoking is prohibited.
2. Refrain from swearing idle chatter.
3. Alcoholic beverages, soft drinks or food is not allowed in the do jang.
4. Wearing shoes is prohibited.
5. No one is allowed to teach without the instructor's permission.
6. No one is allowed to leave class without the instructors permission.
7. Official *dobok* must be worn during class.

CONDUCT IN DO JANG

Every student must observe the following conduct in the *do jang* in order to maintain an orderly and effective training hall.

1. Upon entering the do jang, bow to the international Taekwon-Do Federation flag on the wall.
2. Bow to the instructor at a proper distance.
3. Exchange greetings between students.
4. Bow to the instructor upon falling in line before training.
5. Recite the oath prior to training.
6. Meditate for one minute sitting cross-legged after training.
7. Bow to the instructor upon falling in line again prior to dismissal.
8. Bow to the International Taekwon-Do Federation flag before leaving the do jang.

Students bowing to the instructor before training.





Students reciting the oath prior to training.

Students meditating after training.



TRAINING EQUIPMENT

(Sooryon Jangbi)

Certainly Taekwon-Do training does not require expensive equipment, though some simple training aids are needed for *dallyon*, the toughening, forging or developing of necessary attacking or blocking tools and body muscles; And a *do bok* (practice suit) for the spiritual aspect.

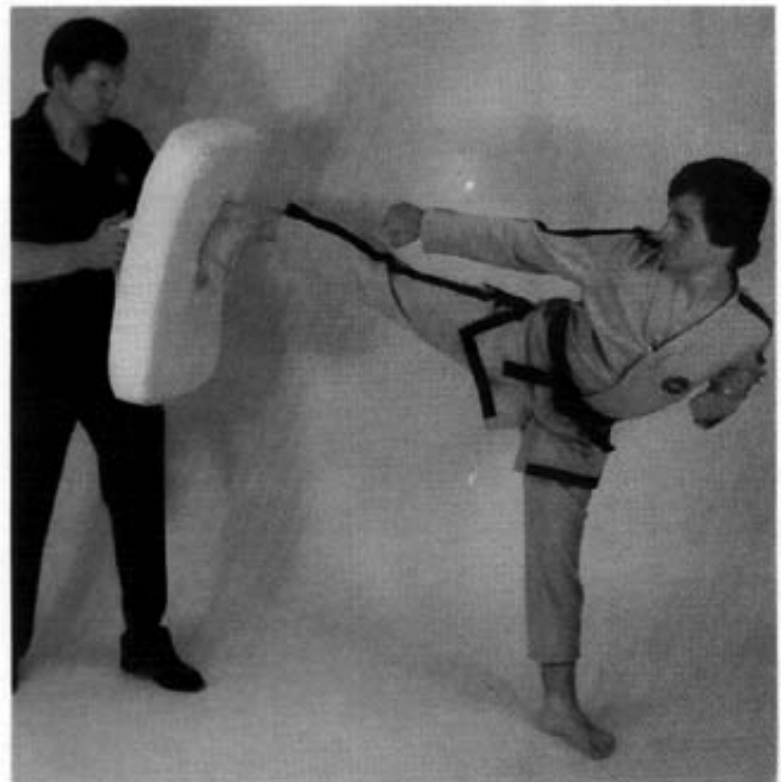

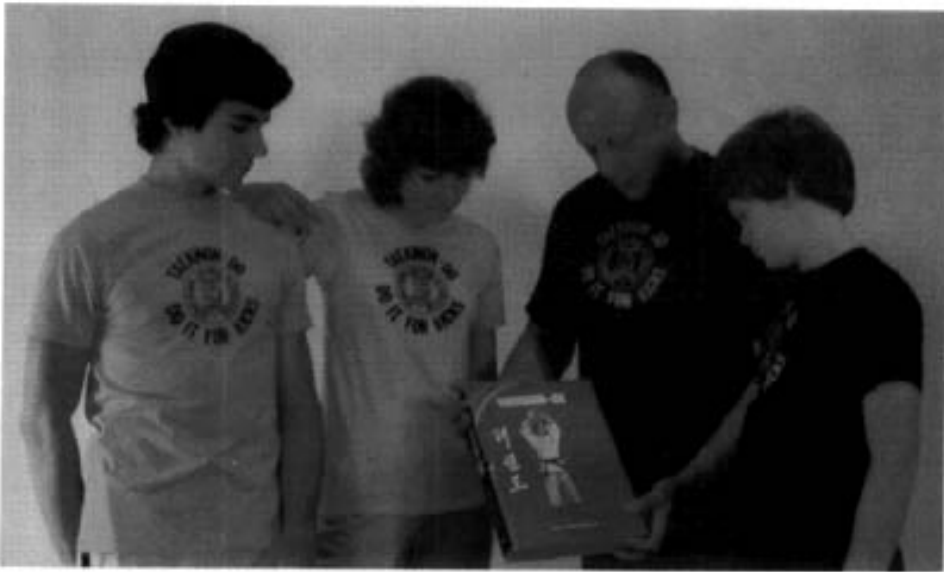

Black belt holder



Front View



Front View

PRACTICE SUIT (*Do Bok*)

We assign names to people and objects in order to distinguish between different individuals, between objects with different properties etc. We know immediately that "Kim Sun Dal" is not the same person as "Timothy Smith", that "flora" is distinct from "fauna", that a "rock" and a "pillow" do not have identical characteristics.

The naming of names is a classification process by which we impose order on the universe. In the absence of names, the world would be chaotic and progress would be impossible. Our *do boks* serve a similar purpose. They reveal our occupation and our rank, identifying us as persons engaged in a certain kind of activity. Social order would be difficult to maintain without systemized forms of clothing.

Because of names, football can be clearly distinguished from baseball, Taekwon-Do from *Judo*. Similarly, their respective uniforms allow us to distinguish a judge from a criminal, a general from a private soldier.

When we wear a uniform, we accept a certain role in society and we are obliged to behave accordingly.

Our martial art was given the name "Taekwon-Do" to distinguish its technique, philosophical system, spiritual foundation and rules of competition from other Oriental martial arts. We have a uniform unique to Taekwon-Do for the same reason.

Grade holder

The International Taekwon-Do Federation introduced this *do bok* in 1982.

It is the product of many years of research and development. This new *do bok* retains the aspects of the traditional *do bok* while representing a new age in terms of design.

It eliminates many of the inconveniences associated with other martial arts uniforms. It will not, for instance, become undone during practice or tournament.

It has also put an end to the dishonest practice of relying on starched material to create an artificial sound.

The *do bok* is considered a primary necessity in both training and tournament for the following reasons:

- (1) The wearing of the *do bok* should instill pride in the student as a practitioner of Taekwon-Do.
- (2) It identifies the degree of skill and cultural education in Taekwon-Do that the individual has attained.
- (3) The style of the *do bok* is symbolic of Taekwon-Do heritage and tradition.
- (4) Grade and degree changes indicated by belt color create incentive while simultaneously preserving humility.



Back View



Back View

(5) The *do bok* is extremely practical and healthy.

(6) The official *do bok* distinguishes orthodox Taekwon-Do from its imitators.

The *do bok* consists of a shirt, pants and belt made of a synthetic material, detron mixed with cotton. This material is a vast improvement over standard cotton in that it is more durable and flexible.

The shirt and pants must be white in color to symbolize the traditional color of the Korean costume. Superfluous frills, piping, lettering and designs are not permissible.

It is very important for the student to keep his *do bok* clean at all times, wear it correctly and treat it with the respect he owes to his art. Black piping around the edge of the shirt is worn only by the black belt holder.

The piping is three centimeters in width and is symbolic of the royal family and members of aristocratic houses during the Koguryo, Baekje and Silla Dynasties.

An international instructor is distinguished by black stripes three centimeters wide on both sides of the shirt and pants.

International instructor



Side View

Black belt holder



Side View

SHIRT (*Sang-i*)

A tapered shirt is both more practical and aesthetically pleasing than a tight or loose one. The sleeves should be long enough to reach the wrist. The length of the shirt should be to the top of the thigh.

It is permissible to wear a T-shirt under the *do bok* if the student desires to do so.

Front View



Back View



The logo symbolizes an evergreen tree.

PANTS (*Ha-i*)

The length of the pants should be to the top of the ankle bone.

Front View



Back View



BELT (*Ti*)

There are six orders of belts: white, yellow, green, blue, red and black. The width of the belt is five centimeters, the thickness five millimeters. The width of the stripe on the end of the belt is also five millimeters. The distance between the stripe and the end of the belt is five centimeters.

Black belt ranks are distinguished by Roman numerals on the belt as shown below.

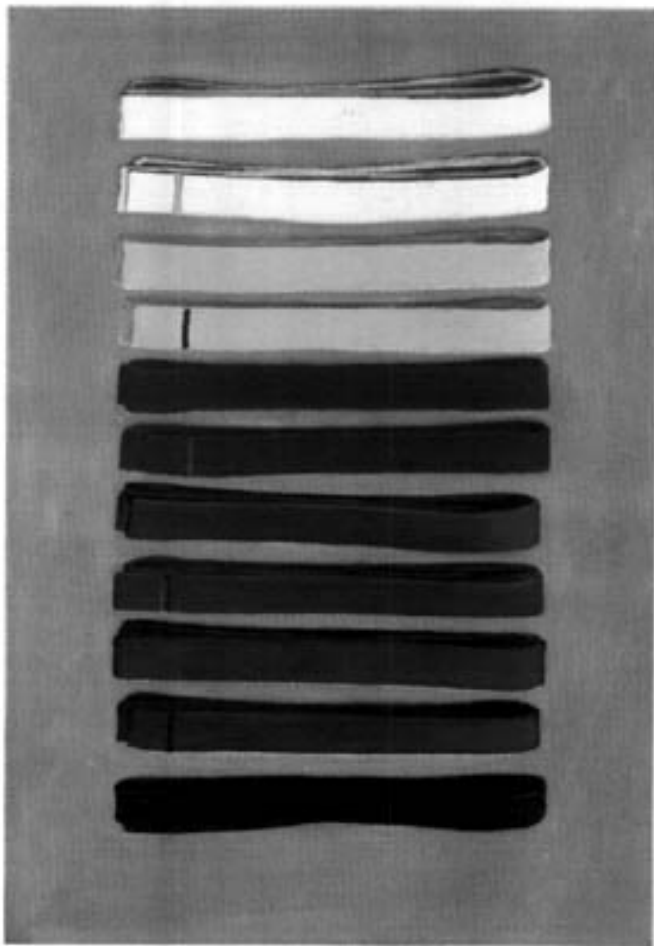

Grade holder's belt

Black belt

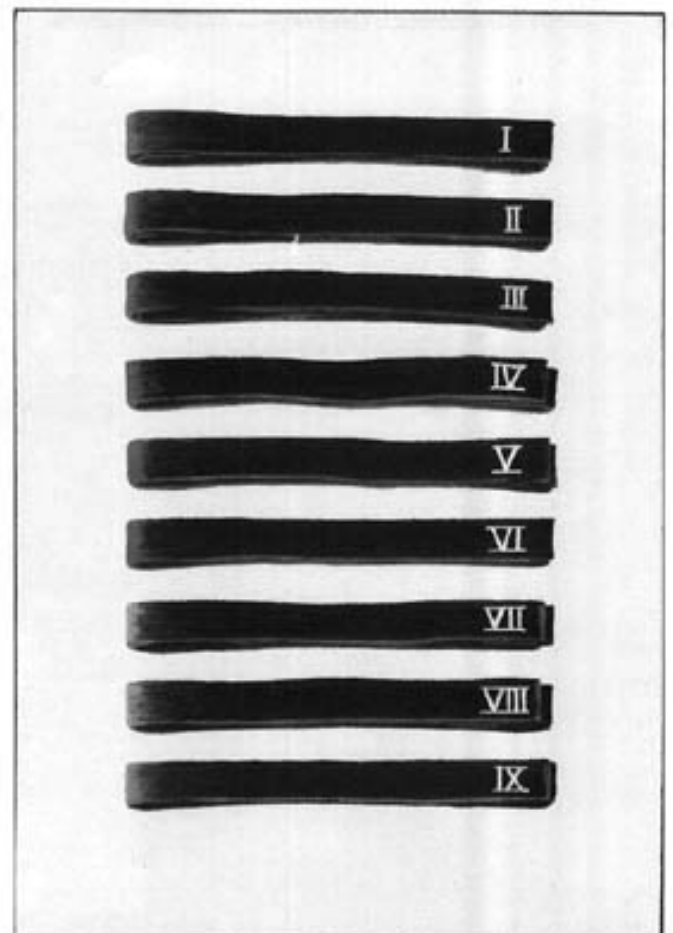

Type of belt	Rank
Black belt	First to Ninth Degree
Red belt with a black stripe	First Grade
Red belt	Second Grade
Blue belt with a red stripe	Third Grade
Blue belt	Fourth Grade
Green belt with a blue stripe	Fifth Grade
Green belt	Sixth Grade
Yellow belt with a green stripe	Seventh Grade
Yellow belt	Eighth Grade
White belt with a yellow stripe	Ninth Grade
White belt	Tenth Grade

The above colors have not been arbitrarily chosen. They are, in fact, steeped in tradition. The colors of black, red and blue denoted the various levels of hierarchy during the Koguryo and Silla Dynasties. A half black and half white belt is used for the junior black belt holder.

MEANING OF BELT COLORS

- White—Signifies innocence, as that of a beginning student who has no previous knowledge of Taekwon-Do.
- Yellow—Signifies the Earth from which a plant sprouts and takes root as the Taekwon-Do foundation is being laid.
- Green—Signifies the plant's growth as the Taekwon-Do skill begins to develop.
- Blue — Signifies the Heaven, towards which the plant matures into a towering tree as training in Taekwon-Do progresses.
- Red — Signifies danger, cautioning the student to exercise control and warning the opponent to stay away.
- Black—Opposite of white, therefore, signifying the maturity and proficiency in Taekwon-Do. It also indicates the wearer's imperviousness to darkness and fear.

How to fold the *do bok*



1. Fold at the center vertically.

2. Fold on the third of the lower part.



3. Fold again at the center.

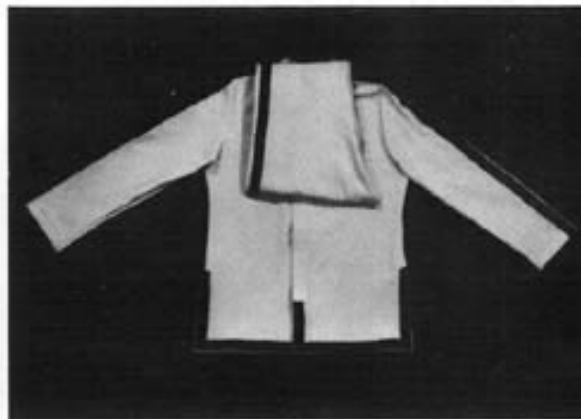

4. Place the folded pants on the shirt so the waist overlaps the collar.



5. Fold one side inward first.

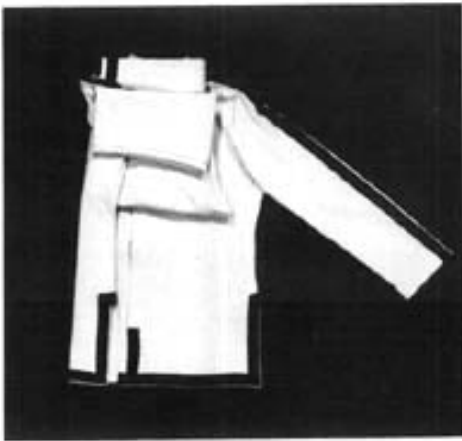

6. Fold the sleeve at the center.

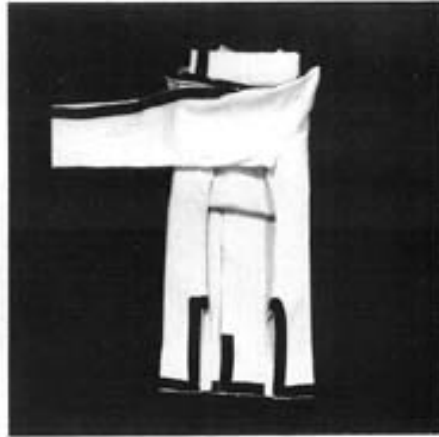

7. Fold the opposite side inward.

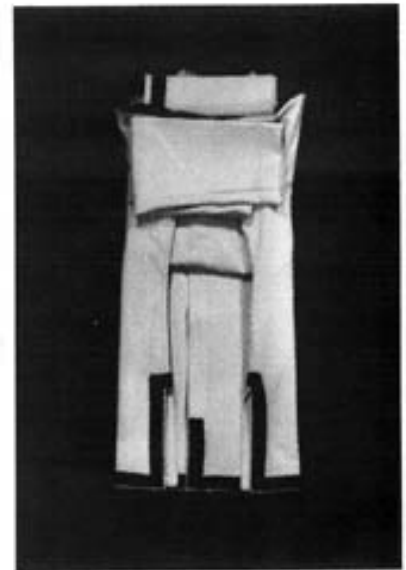

8. Fold the opposite sleeve at the center.

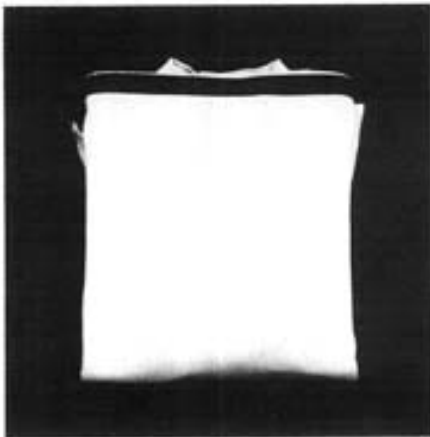

9. Fold the shirt at the center.



10. Fold again in half.

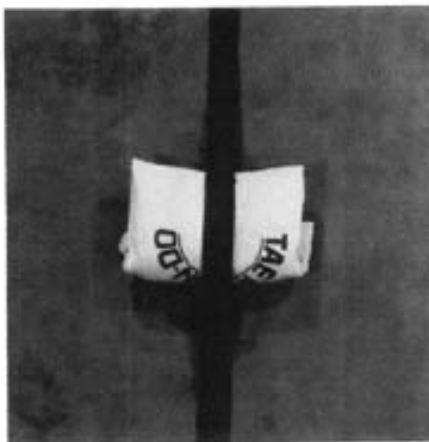

11. Place the center of the folded belt at the center of the folded *do bok*.

12. Tie the belt with a square knot.

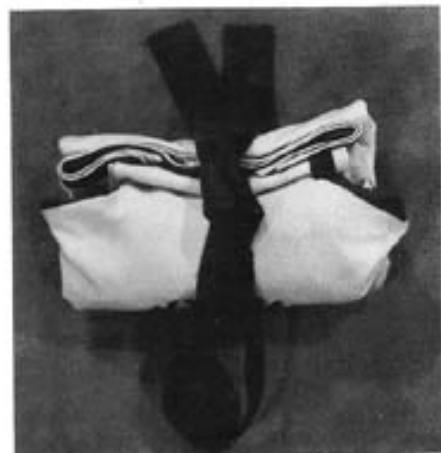

How to tie the belt.

1. Hold the belt at the center.



2. Place the belt on the umbilicus.



3. Wrap it to the ribs.



4. Cross it at the back keeping the belt held with the left hand under the other to prevent the belt from being twisted.



5. Bring the left hand to the abdomen, keeping it as it is.



6. Cross the right end over the belt at the umbilicus.



7. Tighten it with a square knot.



8. Both ends should be of the same length.



INCORRECT
The belt is twisted.



INCORRECT
Both ends are not even.

TRAINING AIDS (*Dallyon Goo*).

Taekwon-Do, like any other sport, requires certain training aids to augment basic expertise.

These aids are invaluable in helping create skill and power with a minimum of time and effort.

Front View

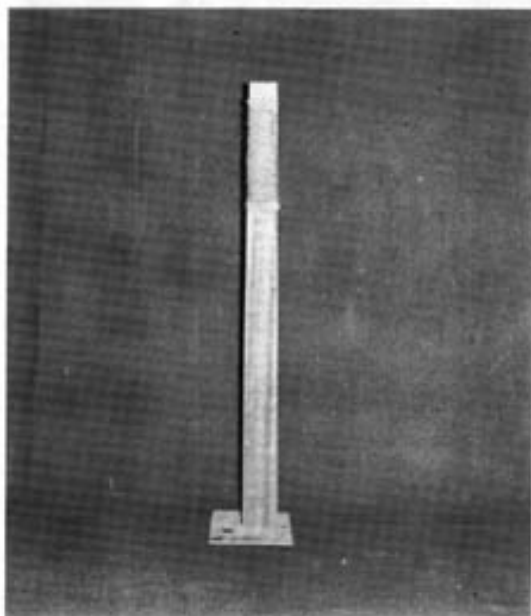

Forging Post (*Dallyon Joo*)

The single best method for toughening the hands and feet while acquiring methods of punching, thrusting, striking and kicking is a forging post.

It is also quite effective for developing speed, accuracy, breath control, concept of the point of focus and posture.

There are four types of forging posts: indoor and outdoor fixed posts, a movable type, a portable type and a mounted type.

Post (Dae)



Directions for Making a Forging Post

Any type of straight square timber will suffice. The length of the post will vary according to the purpose for which it is to be used and the size of the student. Generally, it is approximately seven feet high for an outdoor post and five feet for an indoor post. The thickness at the bottom of the post is about twelve centimeters for outdoor, eight centimeters for indoor, and seven centimeters for a portable board. The back of the post should be beveled from the top to the bottom until the top is three centimeters in width. In this way, the post can preserve its resilience, preventing bone and sinew damage during practice.

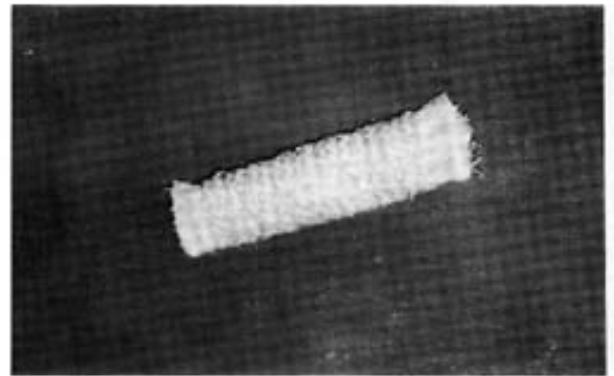

Straw Pad (*Jip Byogae*)

This was used exclusively in the past and is still quite popular. One disadvantage, however, is that since it offers a tough surface, it hampers the speed and accuracy of newer students. The student will soon find that if he does not pull his punches, the attacking tool will be cut or bruised in a very short time. Total length of the pad is twenty-four centimeters; thickness, five centimeters; and width, nine centimeters. Wrap the straw bundle tightly with braided straw rope.



Sponge Pad (*Sponge Byogae*)

This is recommended for beginners. Once the student has toughened his attacking tools, he can then advance to a straw pad. The total length of the pad is twenty centimeters; thickness, six centimeters; and width, nine centimeters. The pad should be covered with canvas.

How to Install Fixed Type (*Gojongsik*)

For an outdoor forging post, dig a hole on level ground. Bury the thickest part in the ground until the top of the post reaches slightly above the solar plexus. Reinforce the buried portion with bricks, stones or crossed bars. The top of the post should be flexible enough to move back and forth three to five centimeters when pushed with both hands. Attach the pad on the unbeveled side of the post, fastening both ends tightly with a thin rope so that the center of the pad reaches the solar plexus.

The post should be fixed so that it leans slightly toward the user. For foot and low kick training, an additional pad can be attached to the lower portion of the post. Instructors should install posts of varying sizes for students.

Outdoor post

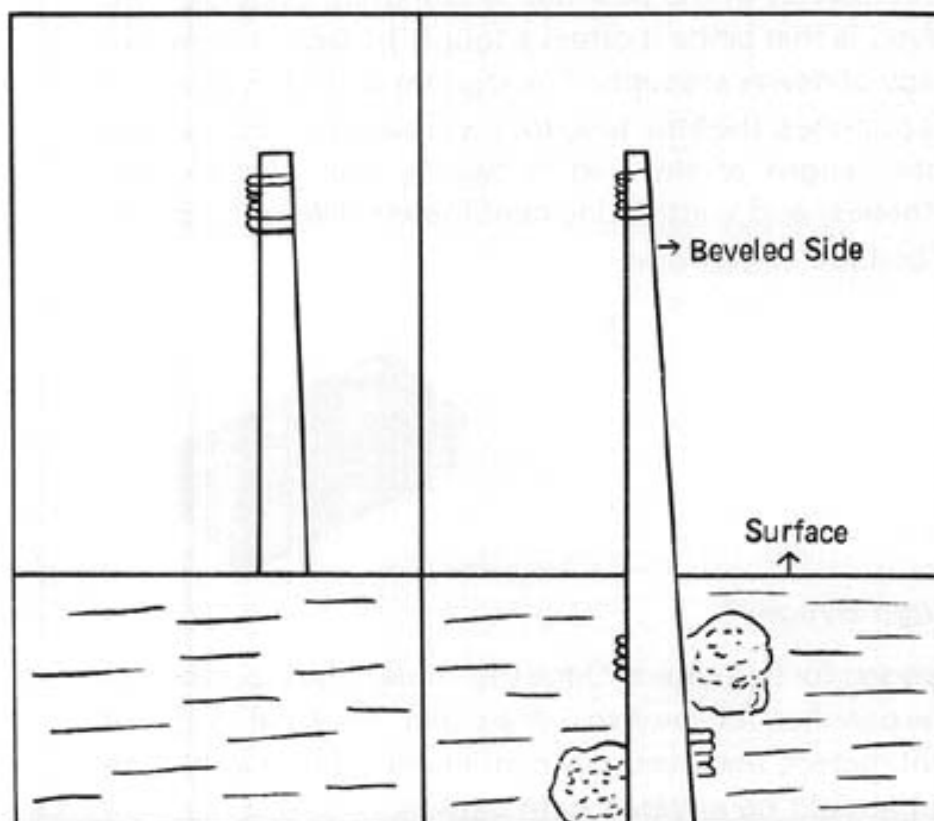

For an indoor post, fasten a concrete block to the bottom of the floor, reinforcing the bottom portion of the post while placing a squared timber against the wall. Insert the post between the concrete block and squared timber, securing the timber with a bolt to prevent movement. A wooden platform can then be built over the concrete block. The concrete block should not be any more than ten by ten centimeters, and the height and width of the squared timber should measure thirty by thirty centimeters and ten centimeters thick.

Indoor Post

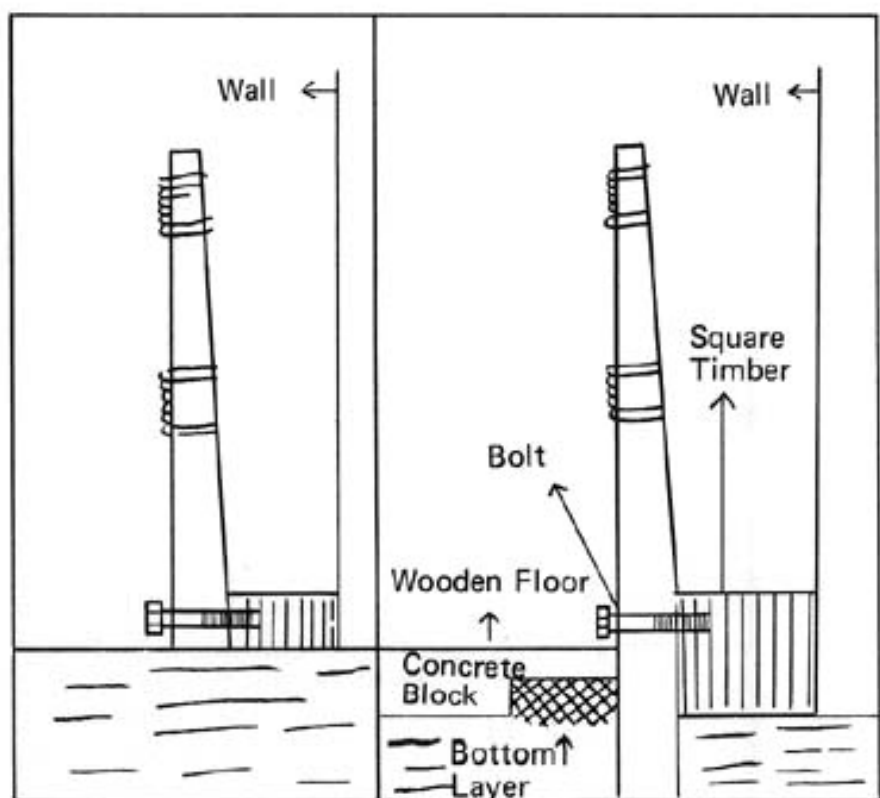

The fixed type forging post, can also serve as a power indicator. The further the post is pushed back when punched or kicked, the greater the power. It is suggested, however, that students use caution when using the forging post. A broken knuckle or tibia bone will set a student's training back weeks or months.

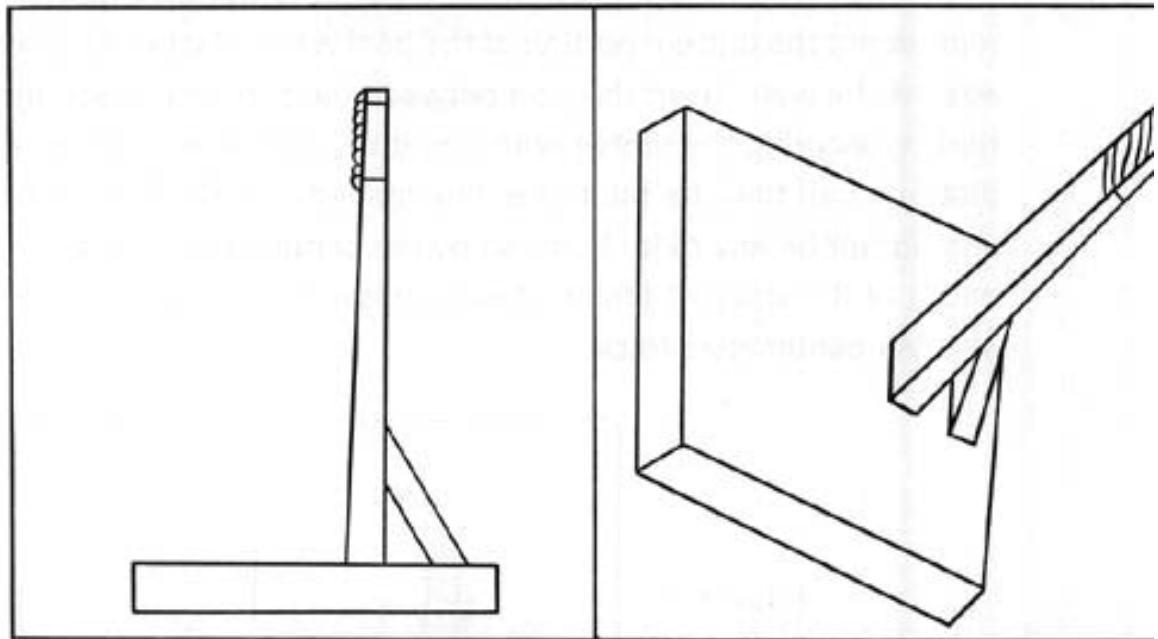

Movable Type (*Idong Shik*)

Make a hole on the wooden base, placing two square timbers as illustrated. Put the forging post into the hole, then cover the wooden base with plywood. Support the back side of the post with a square timber. The size of the wooden base can vary, but the dimensions are usually seven feet by seven feet and the thickness, around ten centimeters. This allows the post to be moved freely and the user to practise with any stance. Both the post and the pad are made in exactly the same method as that of the fixed type with one exception; the bottom ten centimeters are not beveled.

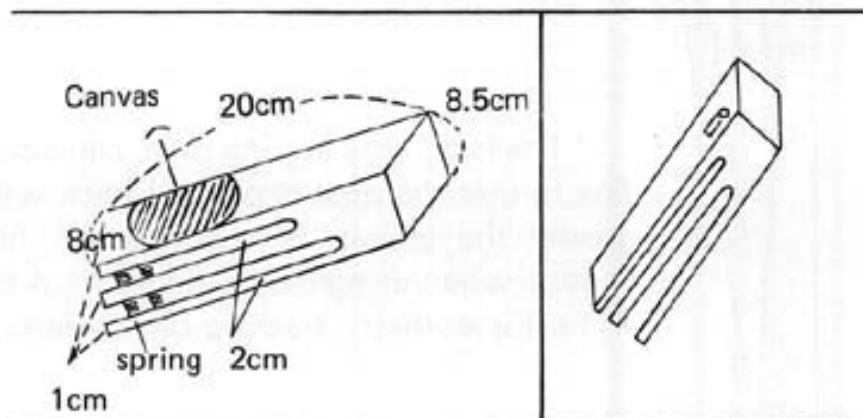

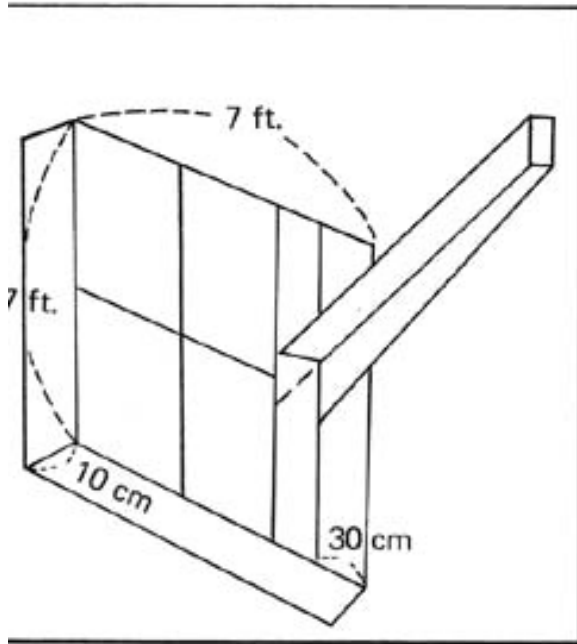

Portable Type (*Heudae Shik*)

Any kind of hardwood will suffice. The size can be flexible but the usual standard size is thirty centimeters in length, eight centimeters in width and nine centimeters in thickness. Here are some additional hints for construction:

1. Fix a spring between the wooden tooth so resilience can be preserved.
2. Put a five-millimeter thick sponge rubber pad on the punching surface, covering it with canvas to prevent bone damage during practice.
3. Make a hole on the back side of it so it can be hung on a peg.

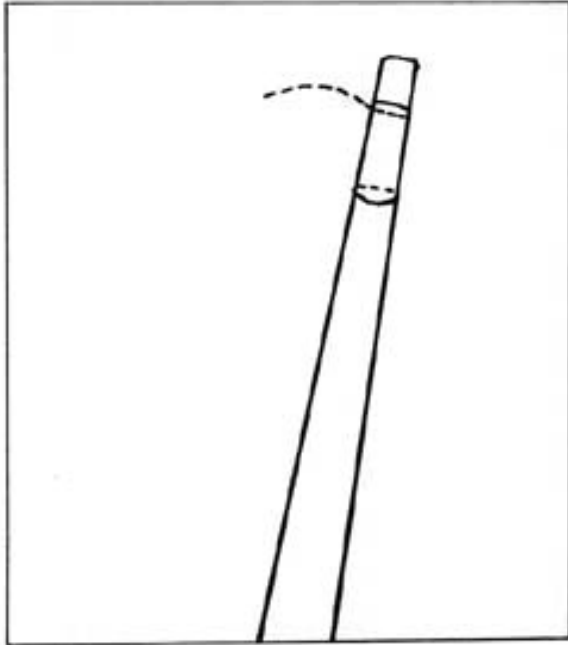

INCORRECT

The fist reaches the pad in an arc rather than a straight line. Strain is, therefore, put on the bent wrist.

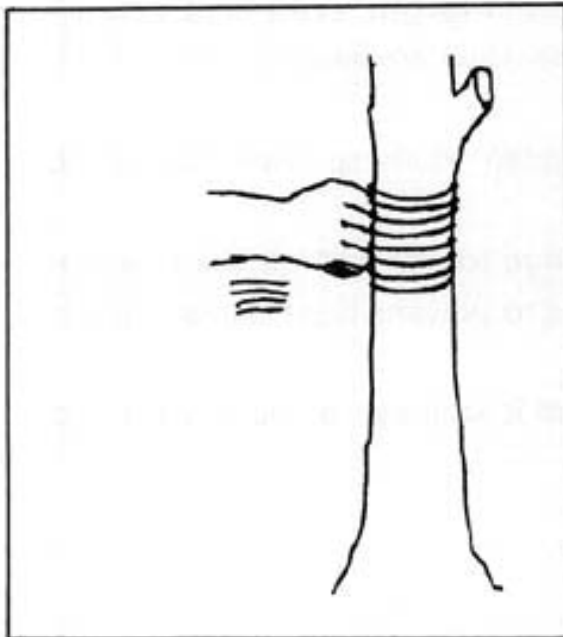

INCORRECT

Since the tree does not offer any resilience, the muscles in the arm and shoulder can be strained. An added disadvantage is that since it is impossible to punch hard, the student fails to build punching speed.

Mounted Type (*Olyo Nonnun Shik*)

This device is basically a forging post mounted on a wooden stand and is very useful for toughening knife-hand, back fist, side fist and back heel.

1. Fix two springs on each side of the rung to provide the necessary resilience.
2. Extra rungs can be added for height adjustment.

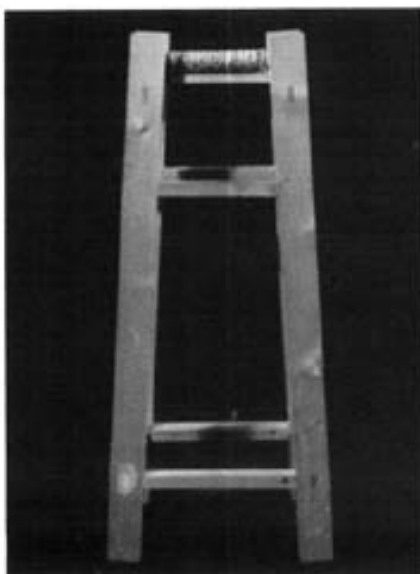
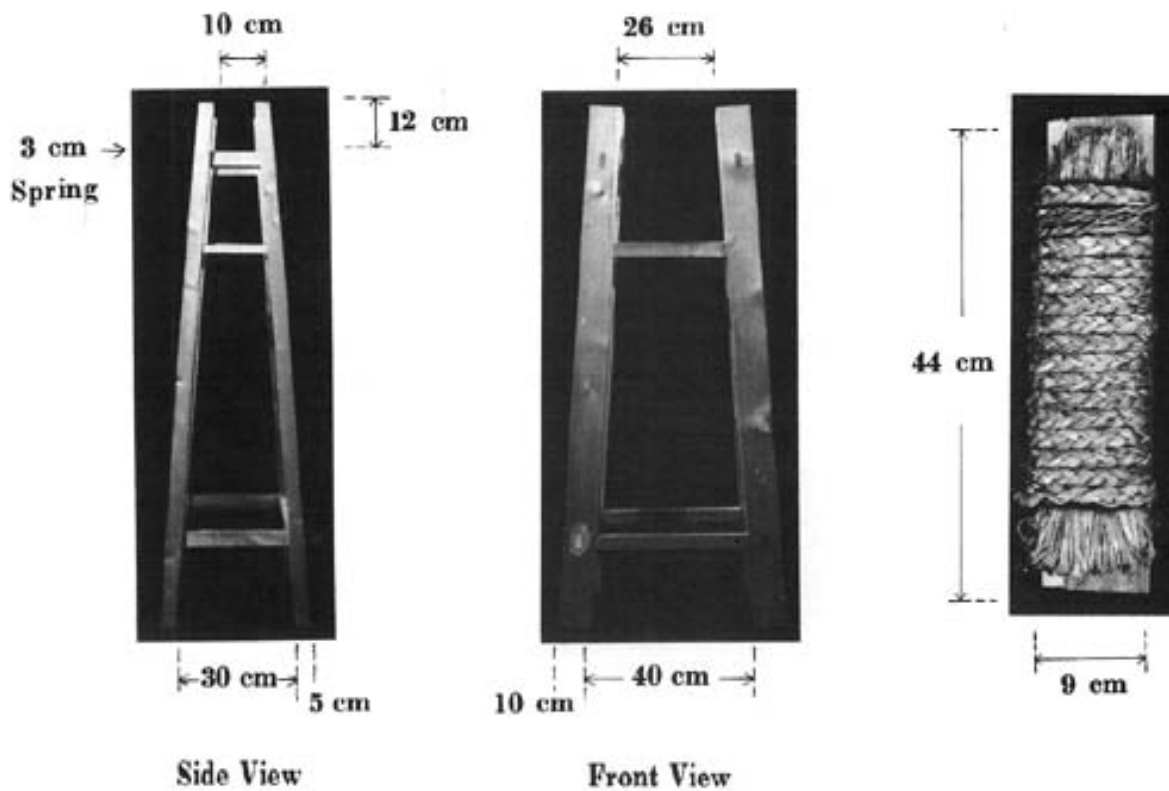

How to Use (*Sayong Bop*)

The forging post must always be regarded as an actual stationary target and faced in a proper well-balanced stance. The basic principles are:

1. The opposite fist should be withdrawn at a greater speed than the punching fist.
2. Do not lift the heel off the ground more than necessary at the start of the punch.
3. Keep the back straight and the heel firmly contacted with the ground at the moment of the punch.
4. Concentrate maximum strength at the moment of impact, focusing at a point one centimeter inside the pad.
5. Exhale the breath sharply at the moment of impact, inhaling when withdrawing the attacking tool.
6. Turn the hip toward the same direction as the attacking tool with a slight shift of body weight.
7. Avoid a pushing or weak punching motion. This not only reduces speed but also develops a weak posture and improper focus.
8. At the moment of impact, freeze the punch for a split second.

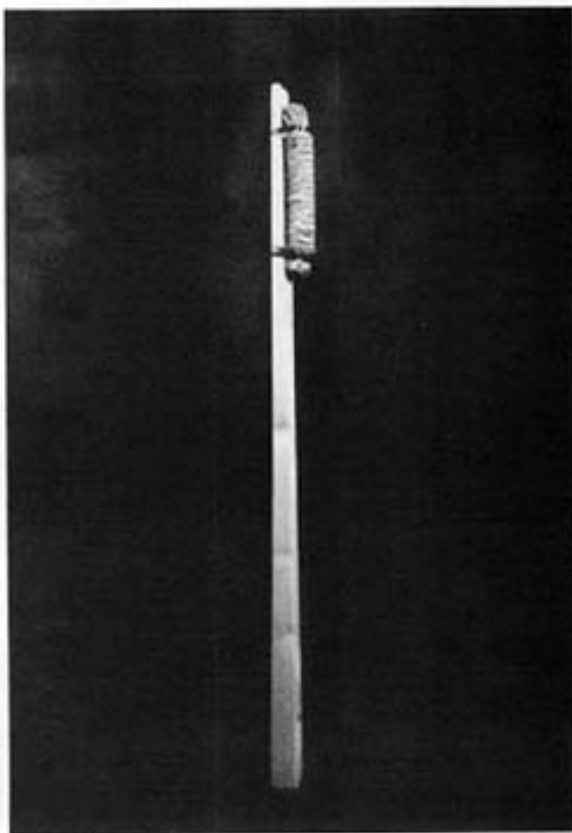

Side View

Forefist (*Ap Joomuk*)

The punching exercise is performed in many ways and with various stances; i.e. punch with parallel or sitting stance, obverse punch with a walking stance, reverse punch with an L-stance etc.

Below are the most typical ones:

Parallel Stance Punch (*Narani So Jirugi*) .

This is for very beginners to acquire accuracy and method of punching with correct posture while toughening the skin of knuckles.

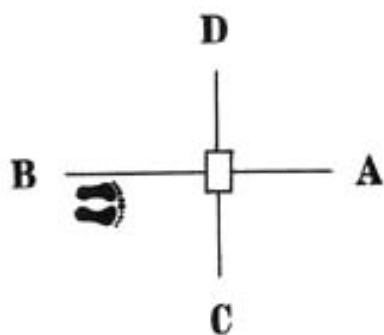

The distance between the toes and the pad is one full arm's length. The small toe of the left foot forms a straight line with the edge of the post.

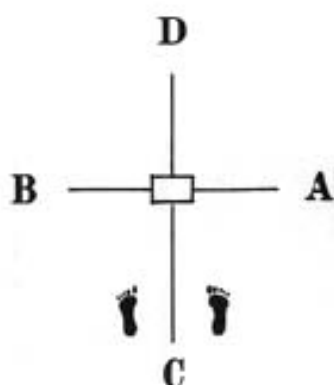

Move the left foot to D to form a parallel stance, extending the left fist horizontally while pulling the right fist to the hip.

Punch with the right fist while pulling the left fist to the hip.



Sitting Stance Punch (*Anun So Jirugi*)

This method together with the parallel stance punch is widely used for beginners, for both fists have equal chance to be trained without changing the position of the feet.

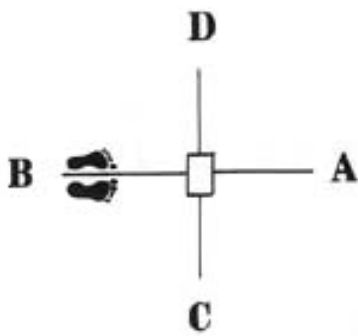

The distance between the toes and the pad is one full arm's length based on a long fist.

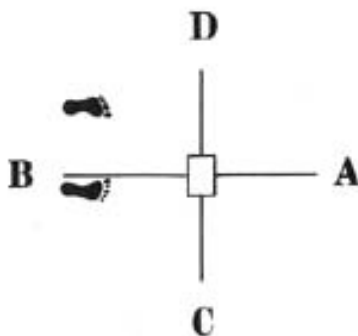

Move the left foot to D.

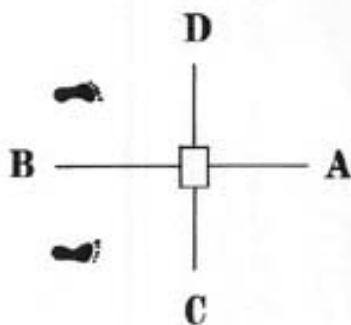

Move the right foot to C, forming a sitting stance while extending the left fist.



Punch with the right fist while pulling the left fist to the hip.

Walking Stance Obverse Punch (*Gunnun So Baro Jirugi*)

This is also widely used for beginners to improve accuracy, correct stance and method of punching as well as toughening the skin of the knuckles.

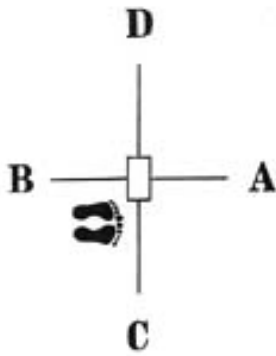

The small toe of the left foot forms a straight line with the edge of the post. The distance between the toes and the post is about five centimeters.

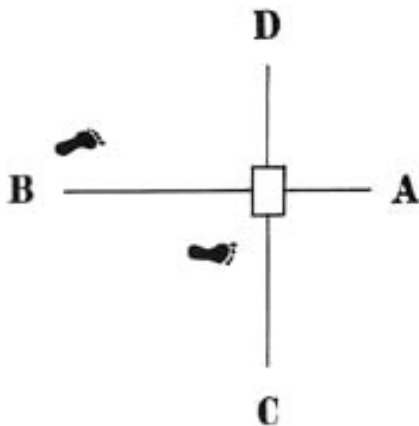

Move the left foot to B to form a right walking stance toward A.



Punch with the right fist while pulling the left fist to the hip.

Walking Stance Reverse Punch (*Gunnun So Bandae Jirugi*)

This is used at all levels for developing speed, posture and breath control as well as the concept of the point of focus and so on.

The distance between the toes and the post is about five centimeters. The small toe of the right foot forms a straight line with the edge of the post.

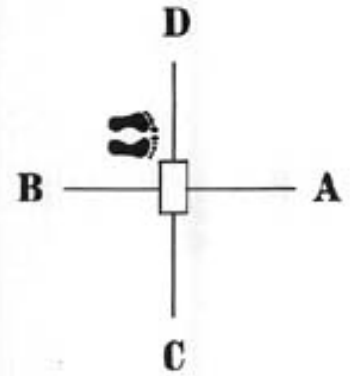

Move the right foot to B to form a left walking stance toward A while executing a low block with the left forearm.

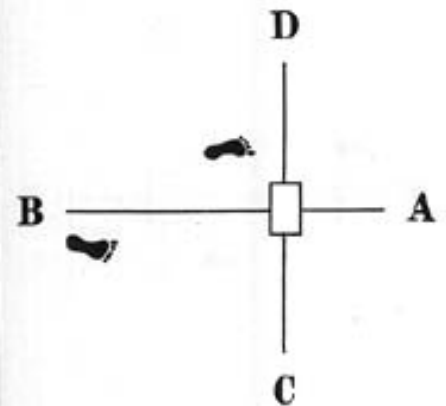

Punch with the right fist while pulling the left fist to the hip.



Front View

L-Stance Obverse Punch (*Niunja So Baro Jirugi*)

Like a walking stance reverse punch this is a very popular punch at all levels.

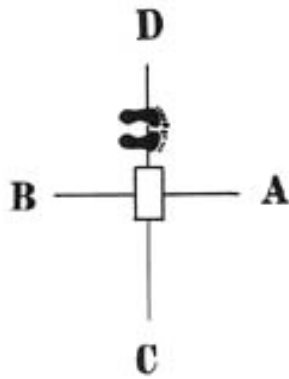

Place the balls of the feet on line D, leaving half a foot of space between the post and the right foot.

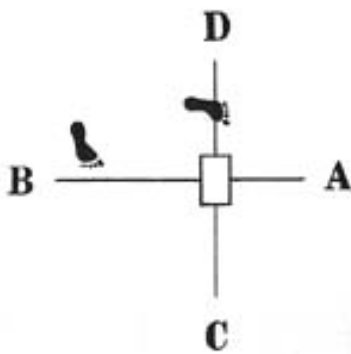

Move the right foot to B, forming a right L-stance toward A while extending the left fist horizontally.



Top View



Punch with the right fist while pulling the left fist to the hip.

L-Stance Reverse Punch (*Niunja So Bandae Jirugi*)

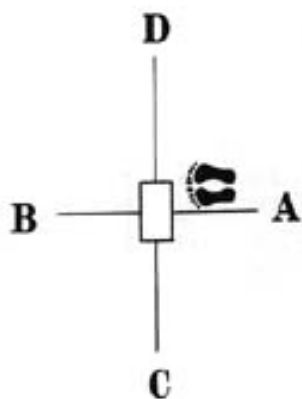

Take a close stance on line facing B so that the big toe of the right foot forms a straight line with the edge of the post. The distance between the post and the toes is half a foot.

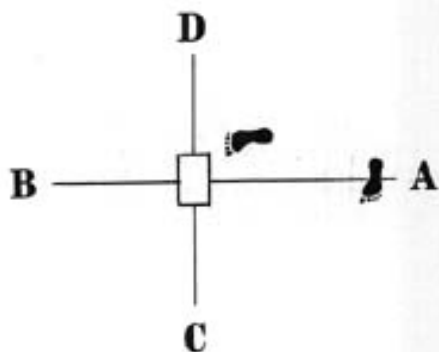

Move the left foot to A to form a left L-stance toward B.



Punch with the right fist while pulling the left fist to the hip.

NOTE: The opposite fist is considered pulled to the hip throughout this chapter unless special directions are given.

Sitting Stance Side Punch (*Annun So Yop Jirugi*)

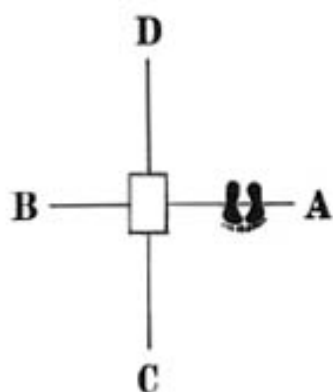

The distance between the right foot and the post is one foot in length.



Move the left foot to A to form a sitting stance toward C.



Punch with the right fist.

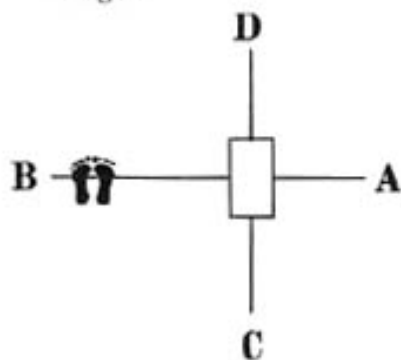

X-Stance Side Punch (*Kyocho So Yop Jirugi*)



Distance between the post and the right foot is one full arm's length based on a flat fingertip.



Cross the left foot over the right foot, forming a right X-stance.



Punch with the right fist.

Walking Stance Upset Punch (*Gunnun So Dwijibo Jirugi*)

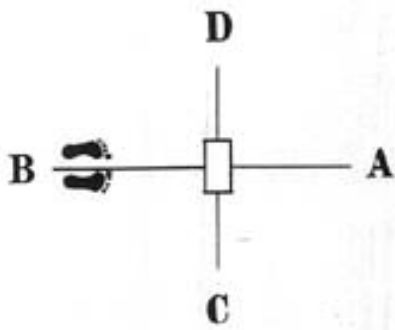

Distance between the toes and the pad is one full arm's length.



Move the left foot to A to form a left walking stance.



Punch with the right fist.

X-Stance Upset Punch (*Kyocho So Dwijibo Jirugi*)

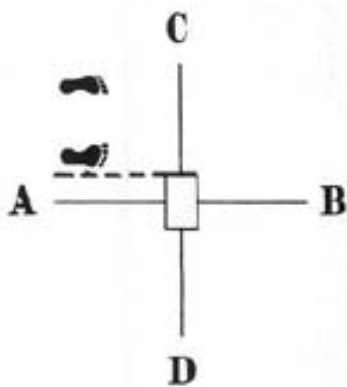

Distance between the toes and the pad is one shoulder width and the small toe of the right foot forms a straight line with the edge of the post.



Cross the left foot over the right foot to form a right X-stance.



Punch with the right fist, bringing the left side fist in front of the right shoulder.

L-Stance Upset Punch (*Niunja So Dwijibo Jirugi*)

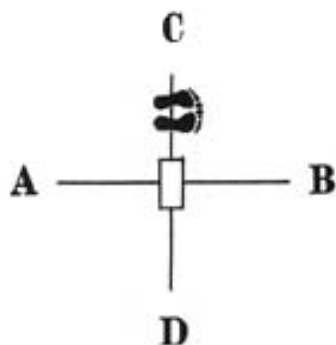

Place the back soles of the feet on line C, leaving half a foot of space between the post and the right foot.



Move the right foot to A to form a right L-stance.



Punch with the right fist, bringing the left side fist in front of the right shoulder.

Forward Stepping Punch with a Walking Stance

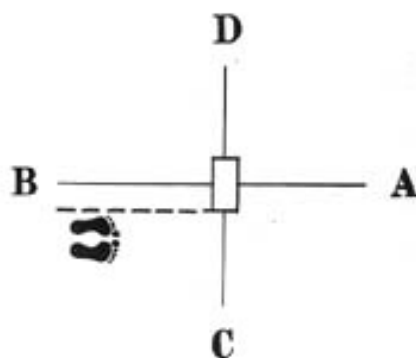

The distance between the post and the foot is one full length of the stance and the small toe of the left foot forms a straight line with the edge of the post.



Punch with the right fist.



Punch with the left fist.

Note: Special attention should be paid to the fact that the unit "foot" used in this chapter is not based on a 12-inch measure. It is to adjust to the varying sizes of the students based on a measure equal to the individual's foot length.

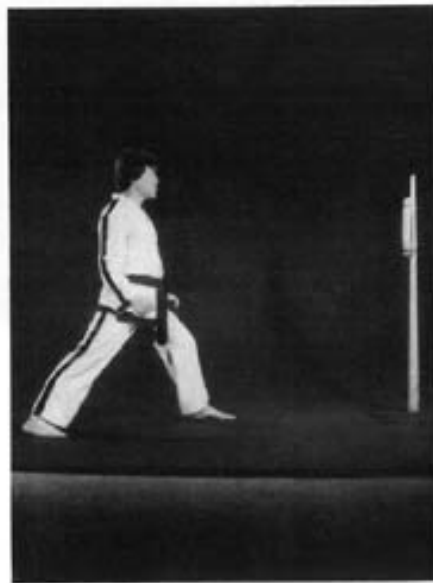
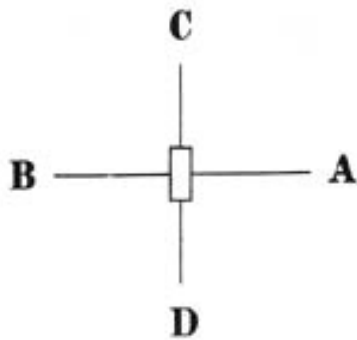

Walking stance punch with double stepping.



One more foot is added for double stepping.

Punches while running.



The distance between the ball of the foot and the post is one full length of the stance.

Take a close stance on line D facing A. The small toe of the right foot forms a straight line with the edge of the post.



Walking stance obverse punch.



L-stance obverse punch

L-stance obverse punch



Walking stance obverse punch



L-stance reverse punch



Miscellaneous Methods of *Dallyon*

The student of Taekwon-Do should expect and have the ability to repel an attack from any direction. Heretofore, this book has emphasized precise motions that must be followed in the exercises. This does not mean, however, that in actual combat a student must always deliver his punch from the hip. Circumstances may not permit him to do so. To augment the fundamental attacking techniques already explained in this book, the following punching methods utilizing various stances are also presented to the student.



The punch is delivered from the chest area.



The punch is delivered from the armpit area.

The punches are delivered from far the hip.

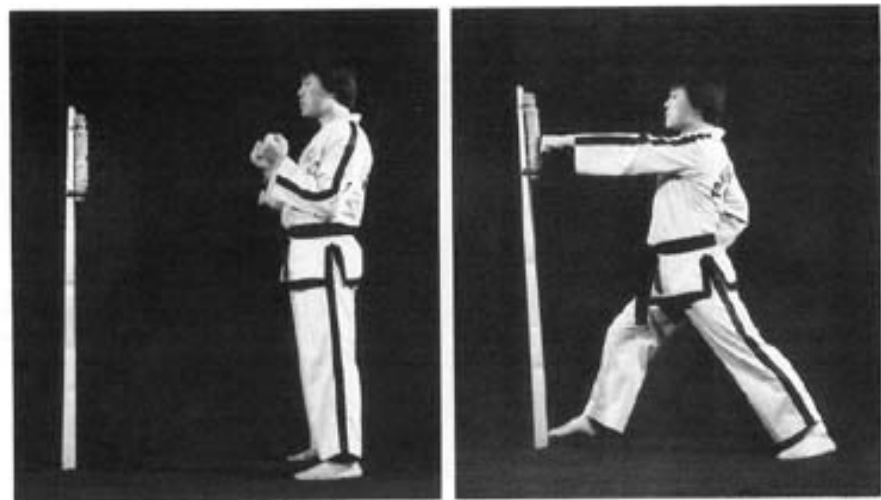
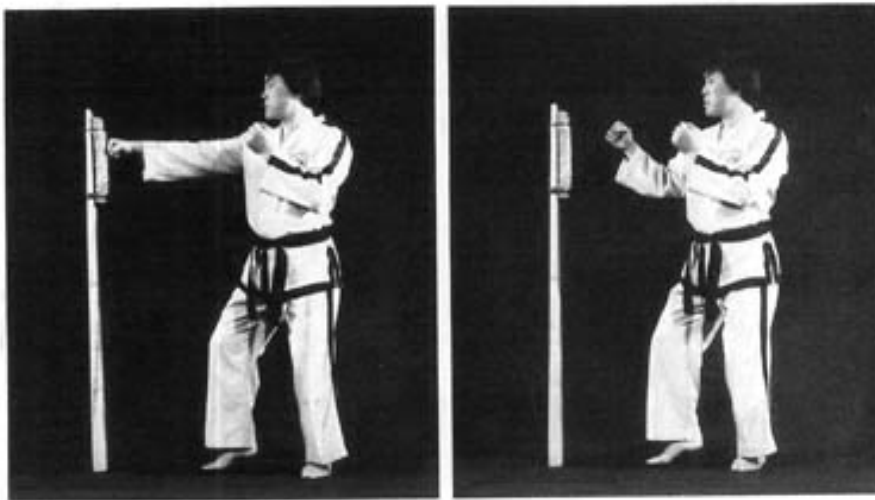
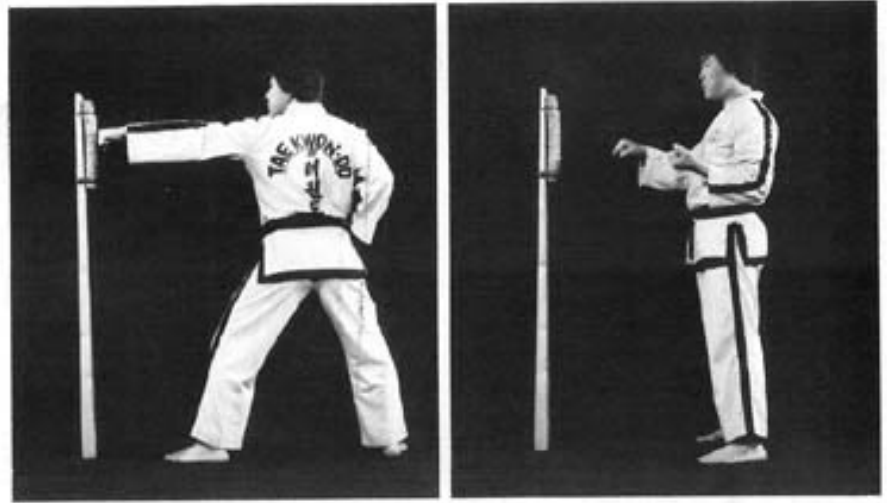



Sitting stance turning punch



Walking stance crescent punch



Downward punch

In all instances, it is best that the student clench his fist slightly rather than tightly at the beginning of a punch, gradually tightening while propelling the punch, then fully tightening it at the moment of impact.



Sitting stance side vertical punch



**Rear foot stance middle
knuckle fist punch**



Knife-Hand (*Son Kal*)

It is executed in four ways: outward, front, inward and downward.

Outward Strike (*Bakuro Taerigi*)

It is mainly performed with walking, sitting, L, vertical, parallel and close stances.

Sitting Stance

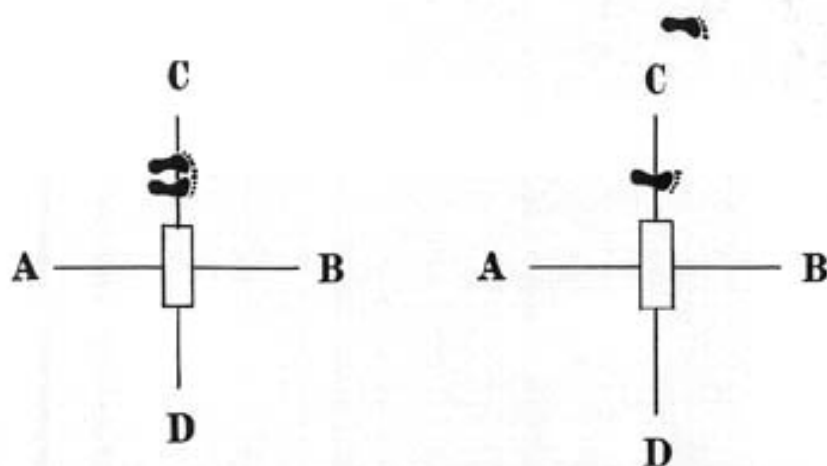

Place the balls of the feet on line C, leaving a quarter of a foot space between the post and the foot.



Turn the back sole of the right foot inward about 25 degrees to form a sitting stance while crossing the right back forearm over the opposite arm.



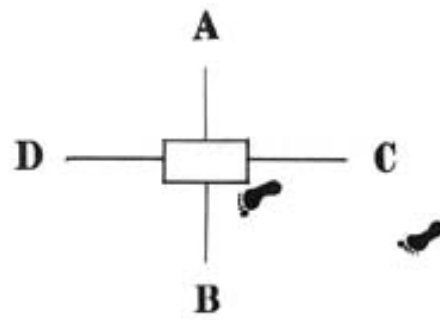

Walking Stance



Place the right foot on line C facing D so that the small toe contacts with the edge of the post.



Turn the back sole of the right foot outward about 15 degrees to form a right walking stance and keep the right back forearm over the other while crossing.



Strike with the right knife-hand.

Strike with the right knife-hand.

L-Stance

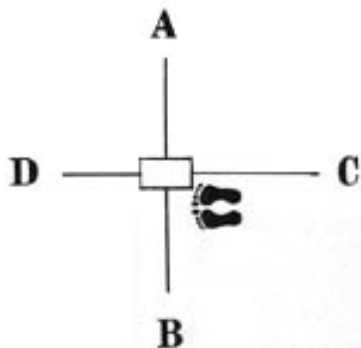

Take a close stance so that the small toe of the right foot forms a straight line with the edge of the post. The distance between the post and the small toe is about a quarter of a foot.

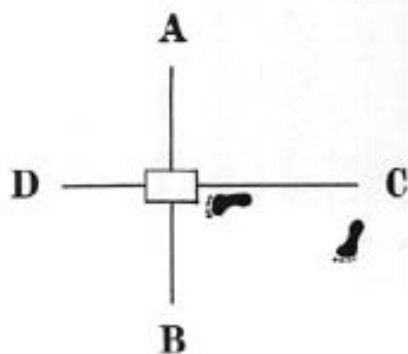

Move into a left L-stance turning the back sole of the right foot outward about 15 degrees.

Strike with the right knife-hand.



Front View

Vertical Stance

Same as in the case with L-stance but the space between the foot and the post is one foot.

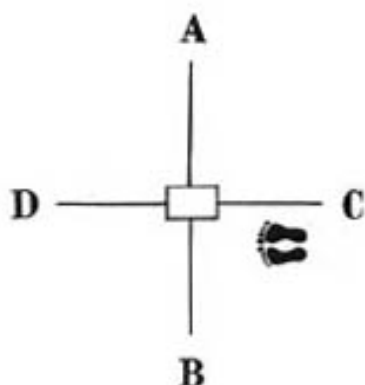

Take a close stance facing D so that the small toe of the right foot forms a straight line with the edge of the post.



Move the left foot to C to form a left vertical stance toward D while crossing the forearms in front of the chest.

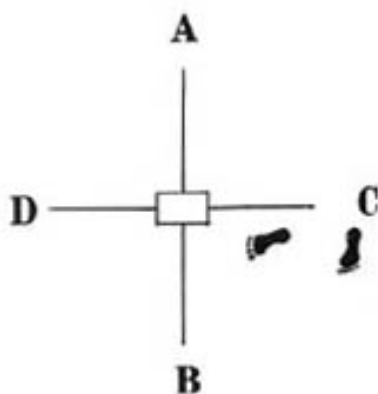

Strike with the right knife-hand.

Parallel Stance

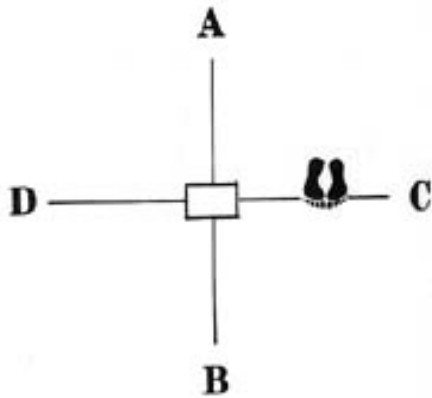

Place the balls of the feet on line C, leaving one and a half feet of space between the right foot and the post.

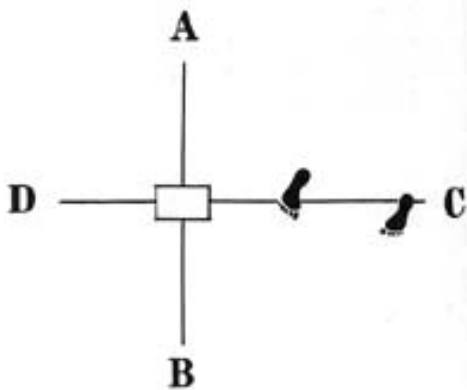

Move the left foot to form a parallel stance toward BD while turning the back sole of the right foot inward about 35 degrees.



Strike with the right knife-hand.

Close Stance

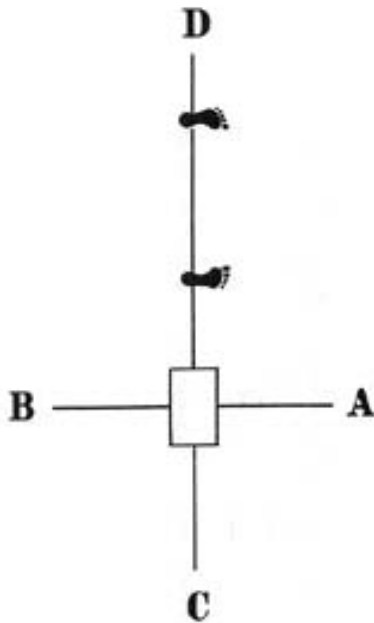

Take a sitting stance, placing the back soles of the feet on line D. The distance between the right foot and the post is two feet.

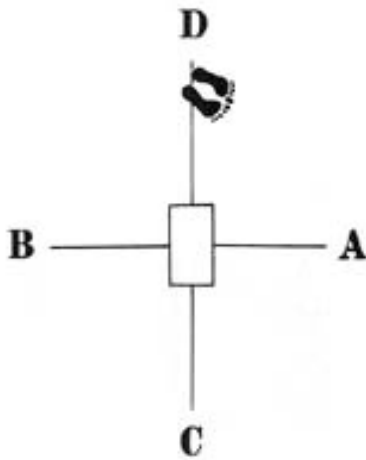

Turn the back sole of the right foot inward about 35 degrees while forming a close stance toward AC.



Strike with the right knife-hand.

Front Strike (*Ap Taerigi*)

It is performed mainly with walking, sitting, parallel, X and close stances. The attacking tool must stay at the center of the body at the moment of impact.

Walking Stance

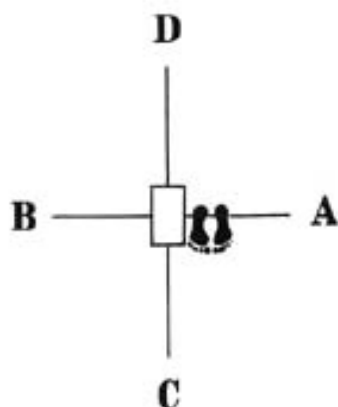

Place the back soles of the feet on line A so that the small toe of the right foot contacts with the edge of the post.



Move into a left walking stance.

Sitting Stance

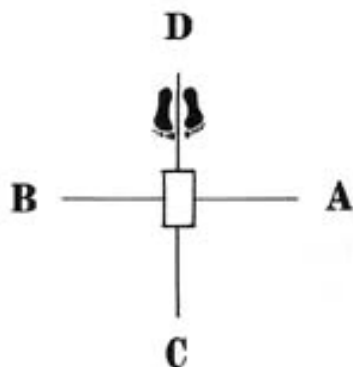

The distance between the toes and the post is one foot.



Move into a sitting stance, spreading both feet equally.

X-Stance

Strike with the right knife-hand, bringing the left back hand in front of the forehead.



The distance between the right foot and the post is one full arm's length, and the big toe of the right foot forms a straight line with the edge of the post.

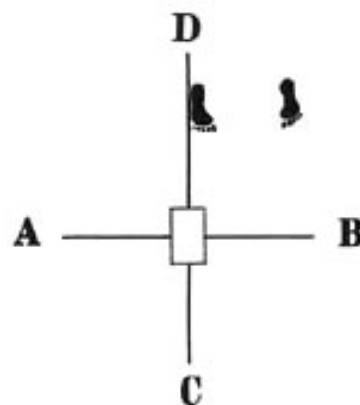

Cross the left foot over the right foot to form a right X-stance.



Strike with the right knife-hand, bringing the left palm on the right under forearm.



Strike with the right knife-hand, bringing the left palm on the right elbow joint.



Parallel Stance

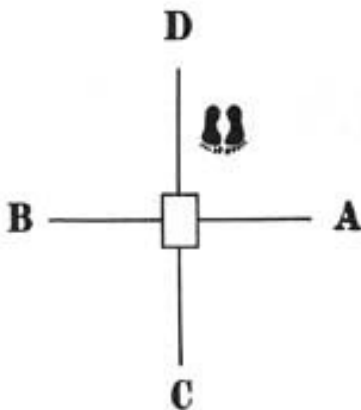

Take a close stance so that the small toe of the right foot forms a straight line with the edge of the post, and the distance between the toes and the pad is one foot.



Move the right foot to B to form a parallel stance.



Strike with the right knife-hand.

Close Stance

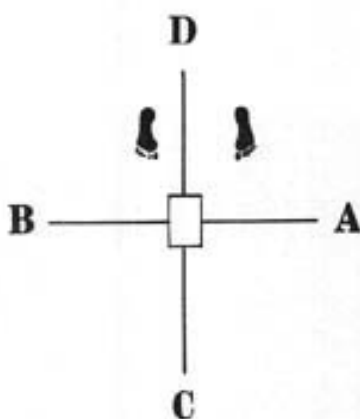

The distance between the toes and the pad is one foot. The right big toe forms a straight line with the edge of the post.

Move the left foot to the right foot to form a close stance.

Strike with the right knife-hand, bringing the left palm over the right elbow joint.



Inward Strike (*Anuro Taerigi*)

It is performed with L, walking, sitting, parallel, X and, close stances. Both the method and procedure are the same as in the case of front strike but the position of the hands, and the center of the pad comes to about the same level as the shoulder instead of the solar plexus.

L-Stance

An obverse strike is normal.

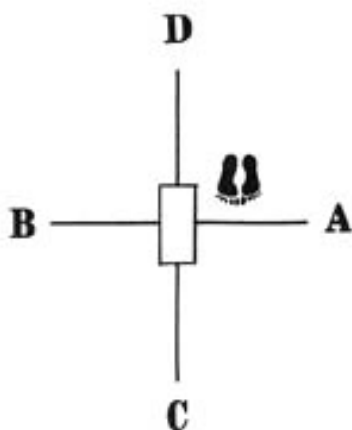

Take a close, leaving half a foot of space between the right foot and the post. The big toes form a straight line with the edge of the post.

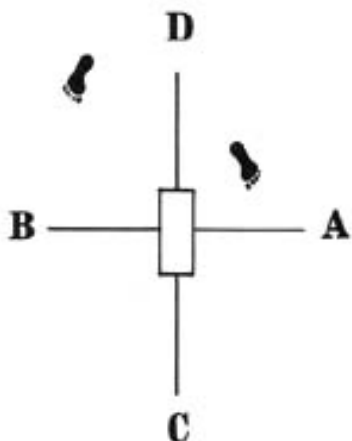

Move the right foot to BD forming a right L-stance toward AC.

Strike with the right knife-hand while bringing the left side fist in front of the right shoulder.



Walking Stance

A reverse strike is more effective.

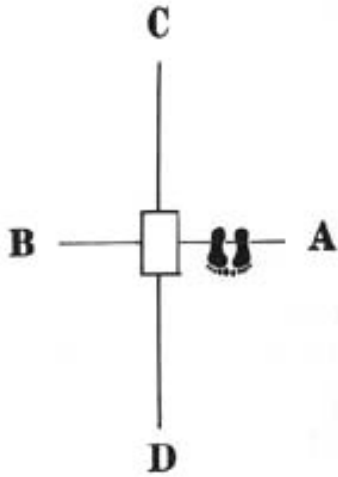

Place the back soles of the feet on line A, leaving half a foot of space between the post and the right foot.

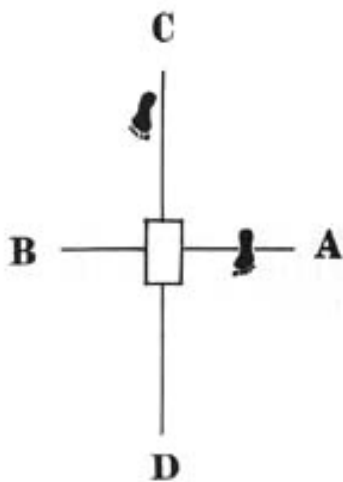

Move the right foot to D, forming a left walking stance toward C.



Strike with the right knife-hand.

Sitting Stance

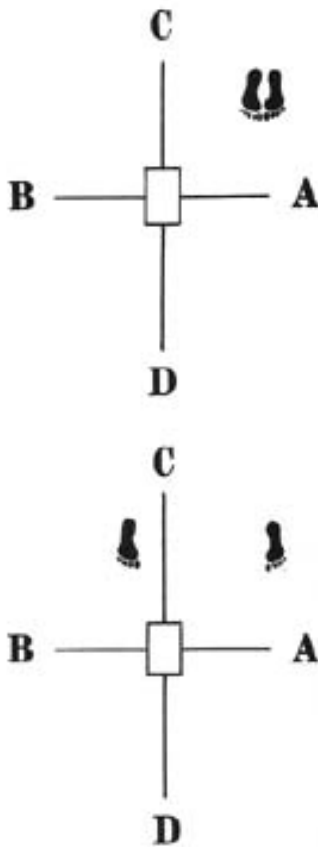

The distance between the toes and the post is one foot and from the right foot to line D is one and a half feet.



Move the right foot to B to form a sitting stance while striking with the right knife-hand.

Parallel Stance



Close Stance



X-Stance



Downward Strike (*Naeryo Taerigi*)

It can be performed with nearly every stance, though close, vertical and walking stances are the most frequently used.

The strike is executed either toward the front or the side. Reverse strike is normal for vertical and walking stances.

Close Stance

The attacking tool reaches the target in either a circular motion or a straight line.



Knife-hand reaches the target in a circular motion.



Knife-hand reaches the target in a straight line.

Vertical Stance

The attacking tool reaches the target in a circular motion only.



Move the left foot to form a left vertical stance.



Strike with the right knife-hand.

Walking Stance

The attacking tool can reach the target in a straight line only.



Move the left foot forward to form a left walking stance.



Strike with the right knife-hand.

REVERSE KNIFE-HAND (*Sonkal Dung*)

Both the method and procedure are also the same as in the case of knife-hand. However, the distance between the post and feet is slightly shorter. This can be executed in three ways, outward, front and inward.

Outward Strike (*Bakuro Taerigi*)

This is performed chiefly with walking, Land rear foot stances. Obverse strike with a walking stance and reverse strike with an L or rear foot stance is common.

Walking Stance

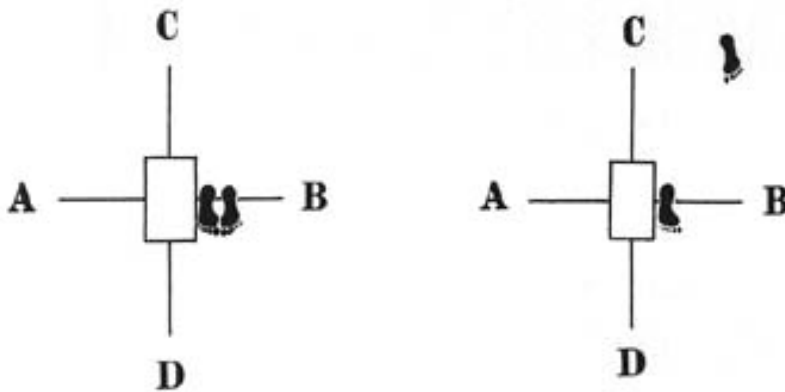

Place back soles of the feet on line B so that the right foot contacts with the post.



Move the left foot to C to form a right walking stance toward D.

Strike with the right reverse knife-hand.



L- Stance

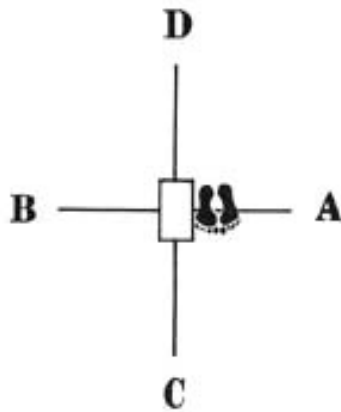

Place the balls of the feet on line A so that the small toe of the right foot contacts with the post.

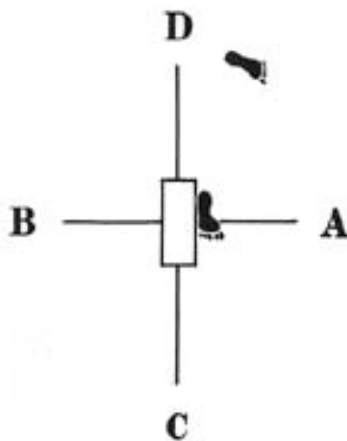

Move the left foot to D, forming a left L-stance toward C.

Rear Foot Stance
—same as in the case of L-stance.



Strike with the right reverse knife-hand.



Front Strike (*Ap Taerigi*)

Both the method and procedure are the same as in the case of knife-hand front strike but the distance between the post and the feet is slightly greater.

It is performed mainly with walking X-and sitting stances.
A reverse strike is normal in the case of walking stance.



Walking Stance



Stitting Stance

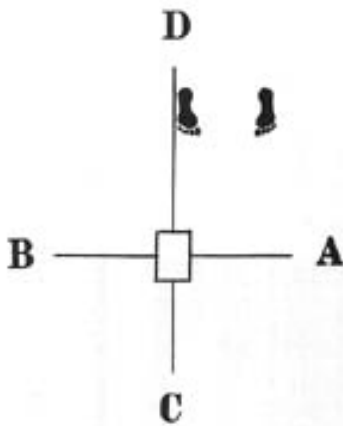

The distance between the toes and the post is one full arm's length and the big toe of the right foot forms a straight line with the edge of the post.



Cross the left foot over the right foot to form a right X-stance.



Strike with the right reverse knife-hand, bringing the left side fist in front of the right shoulder.

Inward Strike (*Anuro Taerigi*)

It is more frequently used than outward strike and is performed mainly with walking, L-and sitting stances.

Both the method and the procedure are the same as in the case of knife-hand inward strike. However, the distance between the post and the feet is slightly shorter. Reverse strike is also normal for L-and walking stances.

Walking Stance

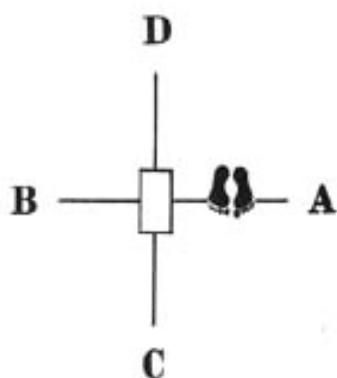

Place the balls of the feet on line A, leaving half a foot of space between the right foot and the post.

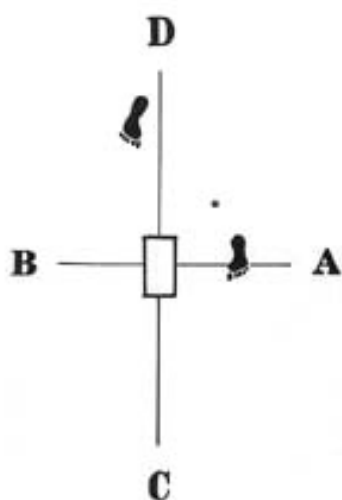

Move the right foot to D to form a left walking stance.

Strike with the right reverse knife-hand.



Sitting Stance

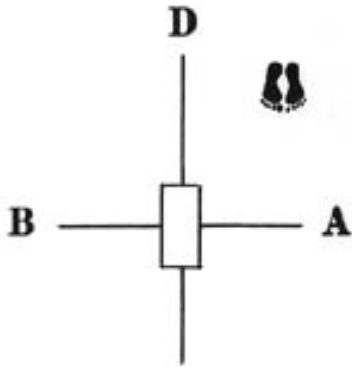

The distance between the small toe of the right foot and the edge of the post is one foot and from toes to line AB is one full arm's length.

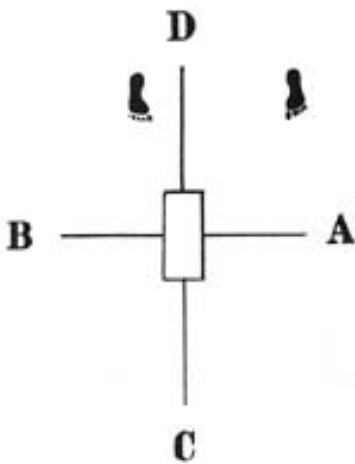

Move the right foot to B to form a sitting stance.

L-Stance

It is better to bring the opposite side fist in front of the shoulder while striking.

Strike with the right reverse knife-hand.



Back Fist (*Dung Joomuk*)

It can be performed with nearly every stance, though walking, vertical, L, X-and sitting stances are the most popular. The strike is executed in two ways, outward and downward.

Both the method and the procedure are the same as in the cases of knife-hand outward and downward strikes. However, the distance between the post and the feet is slightly shorter.

Outward Strike

Walking Stance



Sitting Stance



L-Stance



Downward Strike

X-Stance



Sitting Stance



Vertical Stance



Side Fist (*Yop Joomuk*)

It is executed in three ways: outward, inward and downward. Both the method and the procedure are the same as in the case of knife-hand.

OUTWARD STRIKE

The right back forearm comes over the opposite forearm to cross when striking with the right side fist and vice-versa.

Sitting Stance



Inward Strike



Sitting Stance

X-Stance



DOWNWARD STRIKE

The right back forearm comes under the opposite forearm to cross when striking with the right side fist in a circular motion and vice-versa.

Parallel Stance



Circular motion



Straight line

Vertical Stance

Circular motion



Straight line

Walking Stance



Parallel Stance



Side Elbow Thrust (*Yop Palkup Tulgi*)

It is performed with chiefly L and rear foot stances. Be sure to pull the opposite fist to the hip while thrusting.

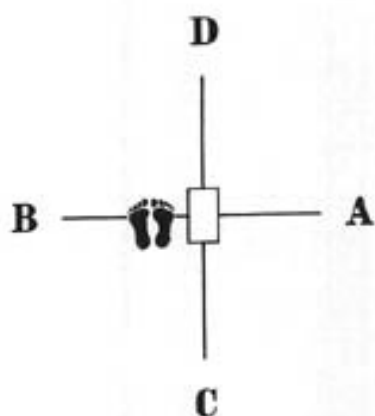

Place the balls of the feet on line **B** leaving half a foot of space between the post and the right foot.

L- Stance



Move the left foot to **B** to form a right L-stance toward **B**.

Keep both back fists faced upward.



Thrust with the right elbow



Rear Foot Stance

Back Elbow Thrust (*Dwit Palkup Tulgi*)

It is performed mainly with sitting and parallel stances, occasionally a diagonal or close stance. Be sure to bring the finger belly of the opposite hand to the forefist while thrusting.

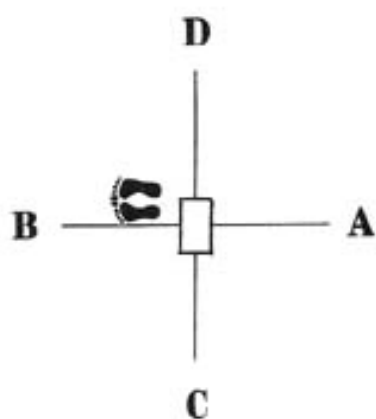

The distance between back heels and the pad is half a foot. The small toe of the left foot contacts with line AB.

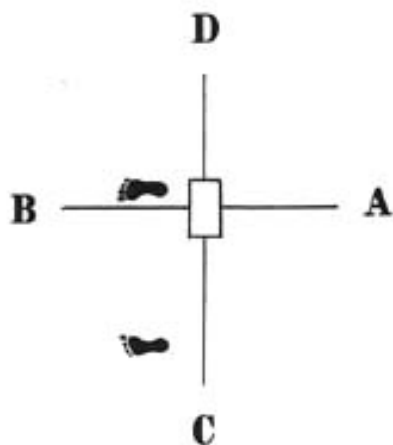

Move the left foot to C to form a sitting stance.

Thrust with the right back elbow.



Front Elbow Thrust (*Ap Palkup Tulgi*)

It is performed chiefly with a walking stance and is executed in the form of a reverse strike. Be sure to press the side fist with the opposite palm when striking.

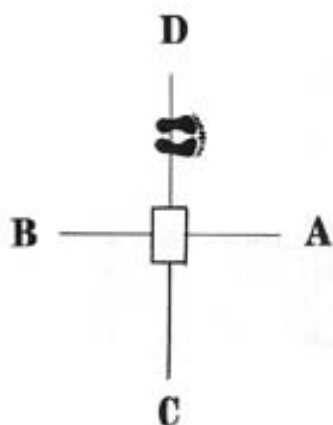

Place the back soles of the feet on line D. The distance between the post and the right foot is one foot.



Move the right foot to B to form a left walking stance, extending the left fist horizontally.



Strike with the right front elbow, pressing the right side fist with the left palm.

Palm (*Son Badak*)

It is chiefly performed with a sitting stance, occasionally a walking stance and is executed in two ways, front and inward. Both the method and procedure are the same as in the case of reverse knife-hand. However, the distance between the post and the feet is slightly shorter.

FRONT STRIKE

The opposite side fists normally brought in front of the shoulder.

Sitting Stance

Walking Stance

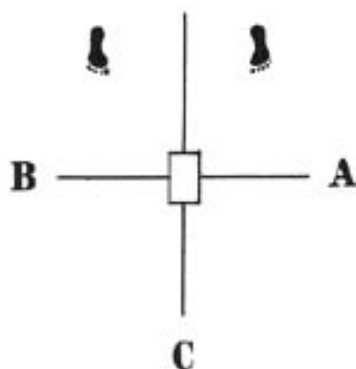

Inward Strike

Sitting Stance

Walking Stance

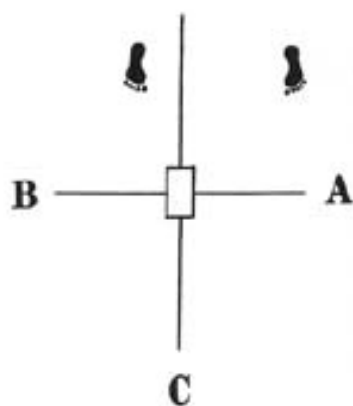

Straight Fingertip (*Sun Sonkut*)

It is mostly performed with a walking stance and is executed in stepping motion. An obverse thrust is normal, occasionally a reverse thrust.

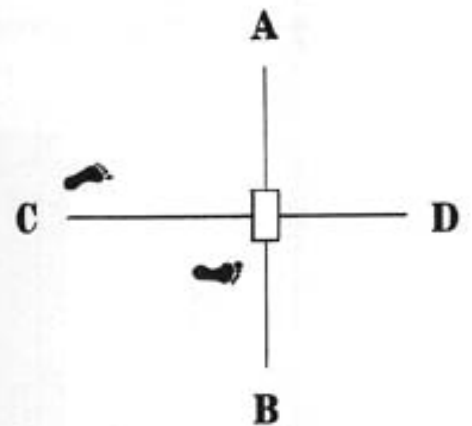

The distance between the big toe of the right foot and line CD is half a foot at the moment of the thrust.

Parallel stance

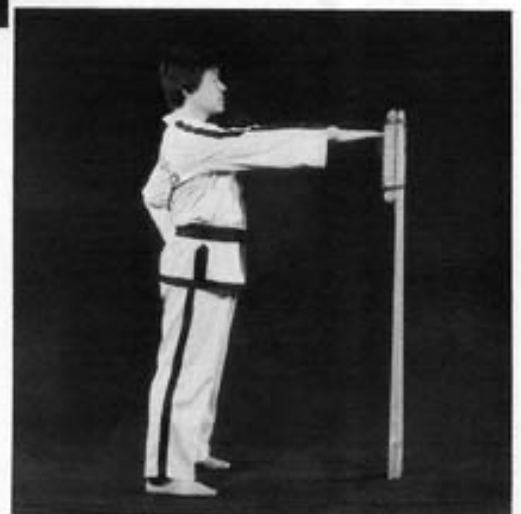

Flat Fingertip

It is chiefly performed with a parallel stance but occasionally sitting and close stances.

Ball of the Foot (*Ap Kumchi*)



Front snap kick

Low twisting kick



Middle twisting kick



Front Snap Kick in Stepping Motion



Turning kick



Side turning kick



Footsword (*Balkal*)



Side piercing kick

Skip side piercing kick

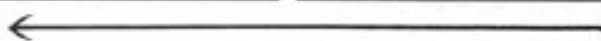

Pressing kick



Reverse turning kick

Back Heel (*Dwitchook*)



Pick-shape kick



Downward kick



Note: The foregoing procedures and methods for right hand and foot training are directly applicable to the corresponding left parts, and the training for left hand or foot is executed conversely. Miscellaneous parts of the attacking and blocking tools such as bow wrist, open fist, instep and forearm can also be trained with the forging post.

When any part of the attacking or blocking tool is injured or the skin is broken, it is wise to focus the blow in front of the post before actual contact or train another attacking or blocking tool.

Forging Bag (*Dallyon Bag*)

There are two sizes of forging bags, large and small. Both of them are excellent training aids, though used for slightly different purposes. The large bag is used mainly for kicking but occasionally punching and striking while the small one is used primarily for flying techniques of the foot and hand.

A forging bag is a must for any training hall. The bag can be a stationary target or swung to represent a moving target. It is an ideal aid for perfecting timing and focus. The bag, if used correctly, can expedite the strengthening of leg and foot as well as arm muscles.

Large Bag



Small bag



Directions for making a bag

The bag should be designed to fit one's choice. It can be made from any material, utilizing nearly any stuffing. Here are some suggestions for an ideal forging bag:

1. The bag should be made of leather or durable canvas, 1 meter 20 centimeters long by 45 centimeters in diameter for a large bag, and 45 centimeters long by 25

centimeters in diameter for a small bag.

2. At least 80 percent of the bag should be filled with sawdust.
3. Canvas or leather patches can be sewn (double stitched) around the mouth of the bag. Iron rings can then be passed through to link with the chain for the large bag and ordinary rope for the small bag which serves as a handle.



Pushing



Ready to kick



Side piercing kick

Turning kick



Front snap kick



Back piercing kick



How to Install

Hang the bag by hooking the handle to a hook suspended from the ceiling. The base of the bag should come to the height of the abdomen. The hook should be attached to either a chain or strong hemp rope which is passed through the rollers on the ceiling. This will enable the bag to be pulled smoothly up and down to adjust for any type of kicking, punching or striking. A small bag can be dropped from the ceiling at any height, according to how it will be used.

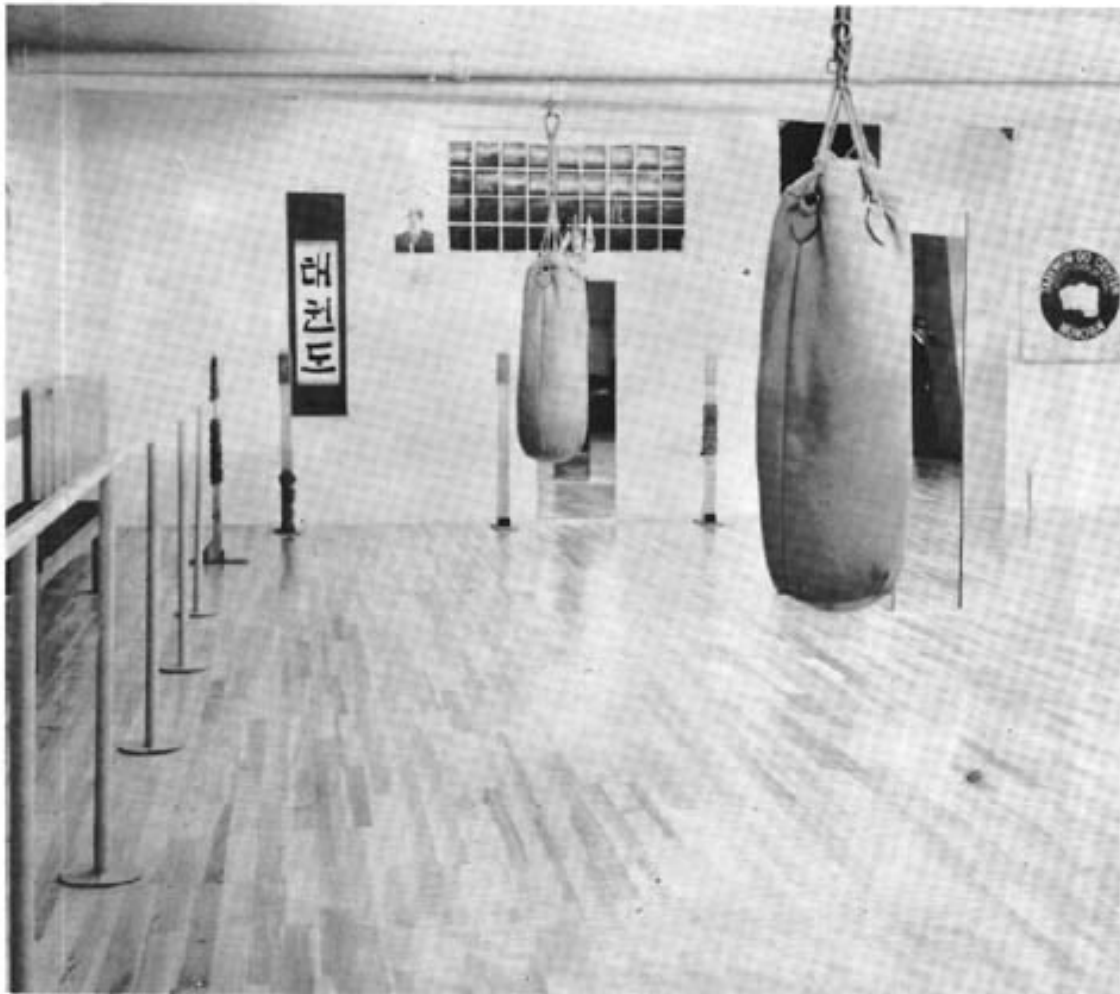

Use of the Bag

For flying kicks, pull the big bag up to at least chest height. The kick should be directed to a point of focus in the center of the bag. For best results, execute running flying kicks from a distance of at least 15 feet. Beginning students should exercise extreme caution in using a forging bag for kicks and should not practice against a moving bag until given permission by an instructor. The big bag is extremely effective for developing power; the small bag, for speed and timing. Both bags can also be used to train the hand parts.

Side thrusting kick



Reverse turning kick

Pushing



Front checking kick



Middle twisting kick





High twisting kick



Outward vertical kick



Inward vertical kick

Side pushing kick



Skip side piercing kick



Skip turning kick



Skip reverse turning kick

Side rising kick



Forefist



Front punch



Side punch



Outward strike



Inward strike

Knife-hand

Reverse knife-hand

Back fist



Flying side piercing kick



Flying high side kick



Flying high turning kick



Flying turning kick



Flying back piercing kick



Flying back pushing kick



Flying inward vertical kick



Flying reverse hooking kick



Flying outward vertical kick

Twin foot front kick



Twin foot side kick

Two direction kick

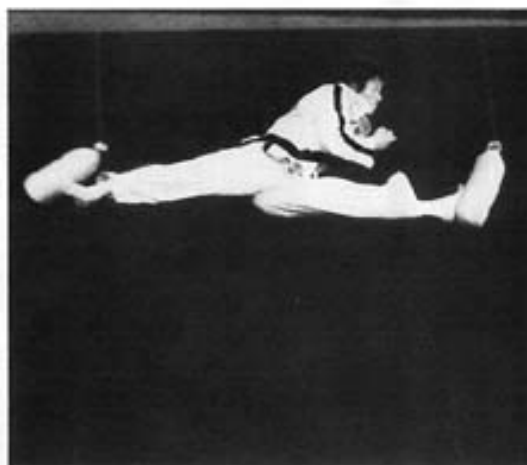

Mid-air kick



Flying high kick



Twin foot high kick



Twin foot turning kick



Twin foot twisting kick



Twin foot reverse turning kick

Dodging side piercing kick



Dodging turning kick



Dodging reverse turning kick

Flying double side kick



Vertical

Horizontal



Flying double turning kick



Flying side front kick



Flying middle turning kick



Flying high twisting kick



Flying side thrusting kick

Flying consecutive kick



**Flying reverse hooking
and turning kick**

Flying front punch



Flying side punch

Flying knife-hand side strike



Flying upset punch



Flying Double Side Punch

Both horizontal and vertical punches are possible.

Horizontally

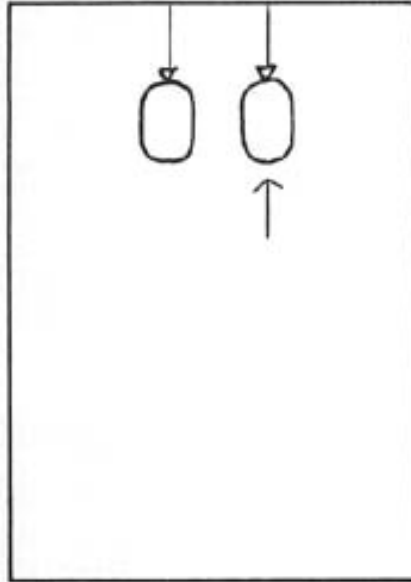
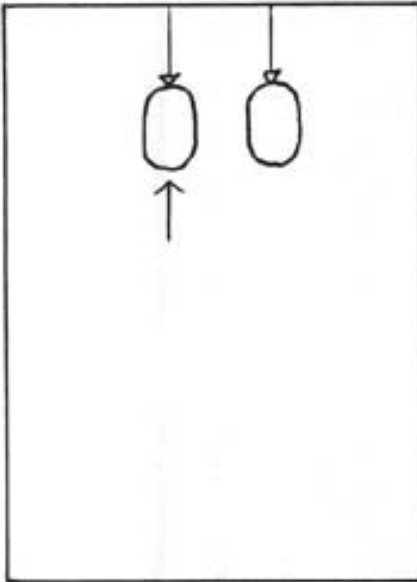

Vertically

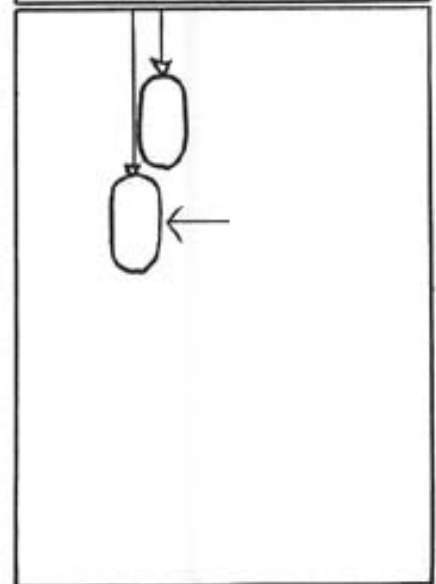
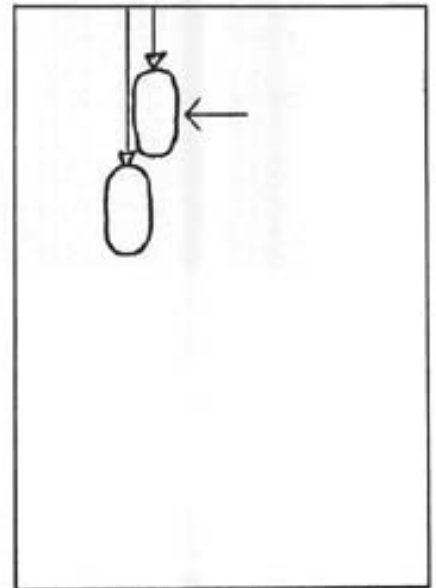

First bag



Second bag

Flying Double Front Punch

Only horizontal punch is possible.

First bag

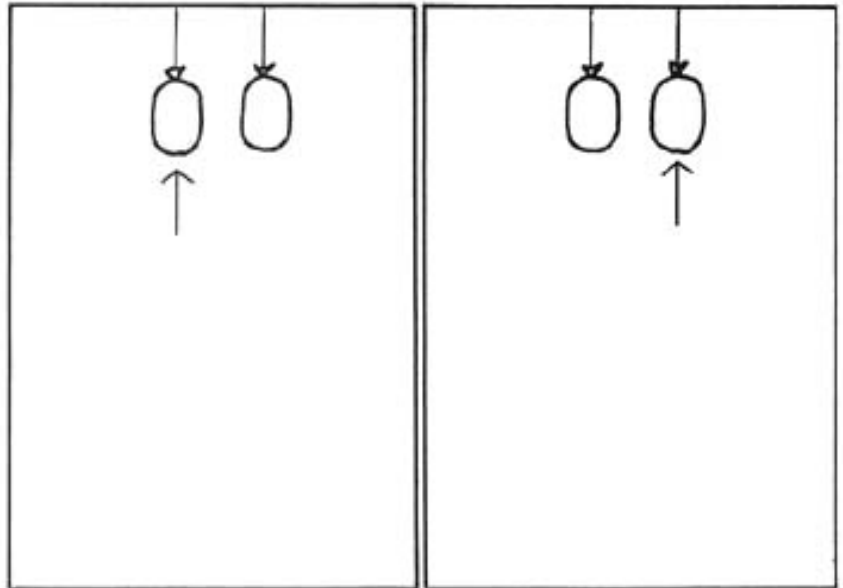

First bag

Second bag



Second bag

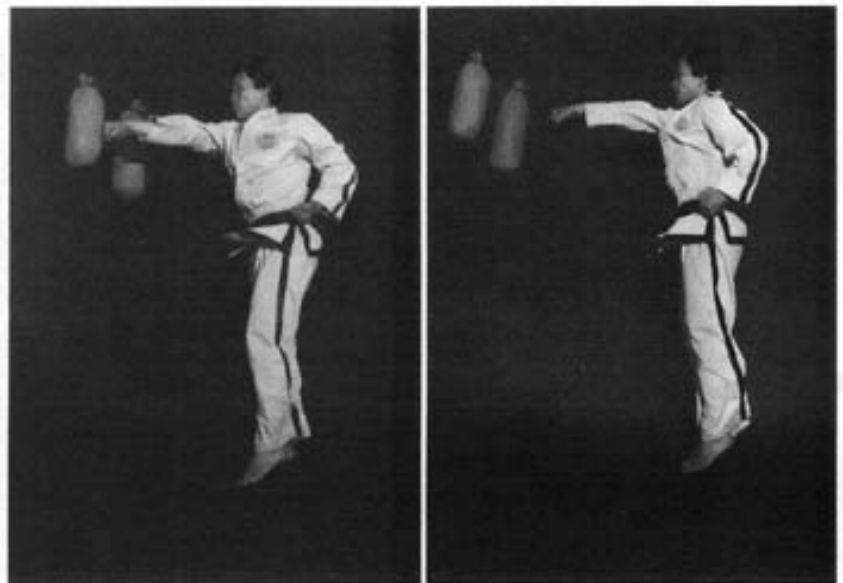

Side View

Flying triple punch can be executed from a single or twin first but only horizontal punch is possible.

Single fist

Both front and side punches are possible.

Side punch

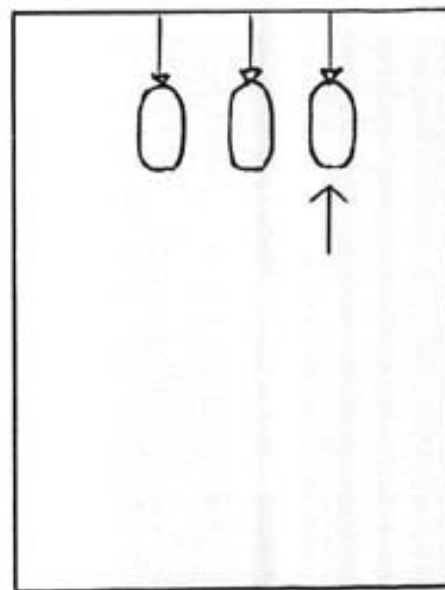
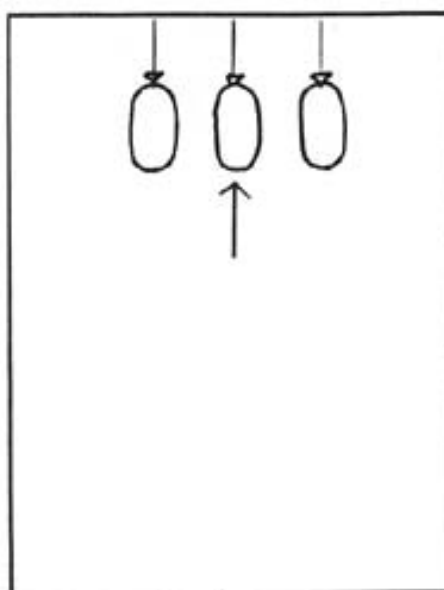
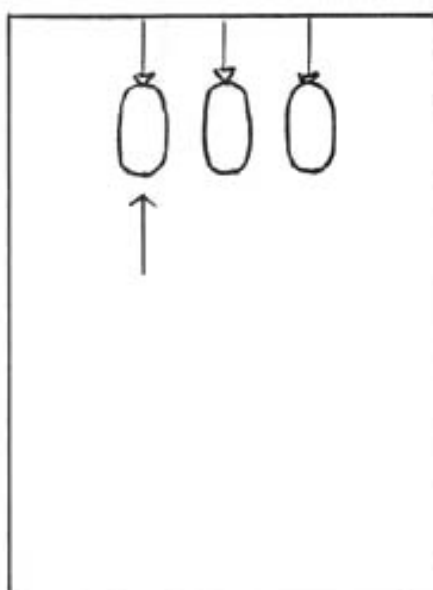

First bag



Second bag



Third bag



Twin Fist

Only front punch is possible.

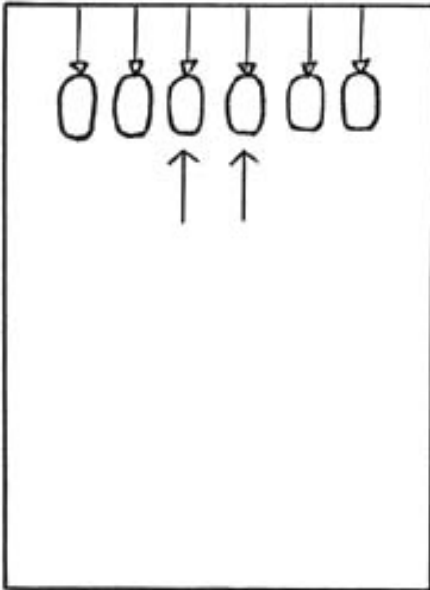

First bags

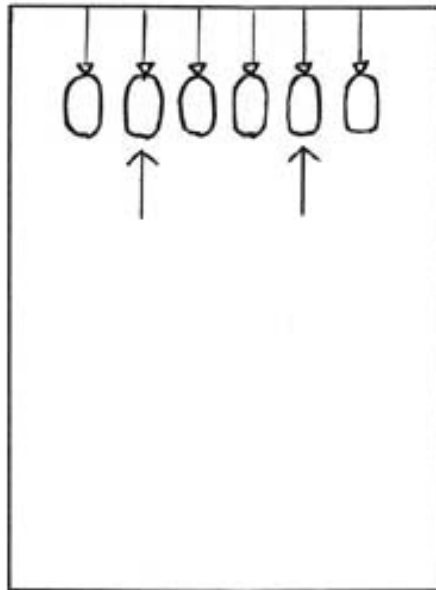

Second bags

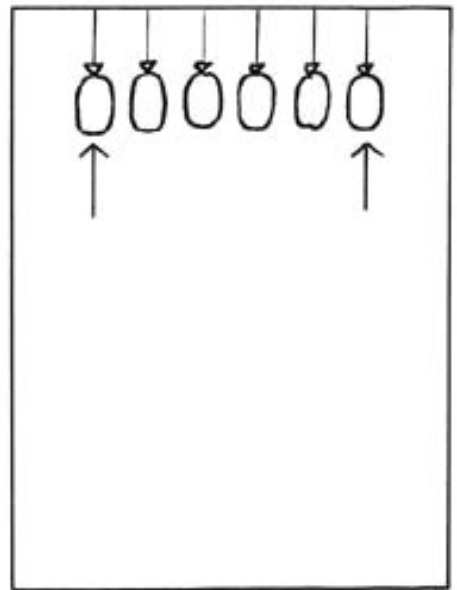

Third bags



Side View

Flying Knife-hand Double Side Strike.

Both vertical and horizontal strikes are possible.

First bag

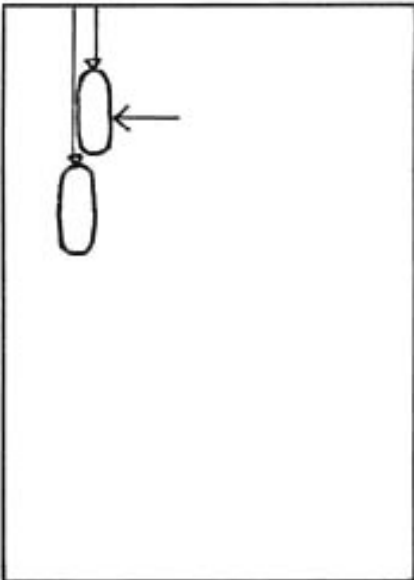

First bag

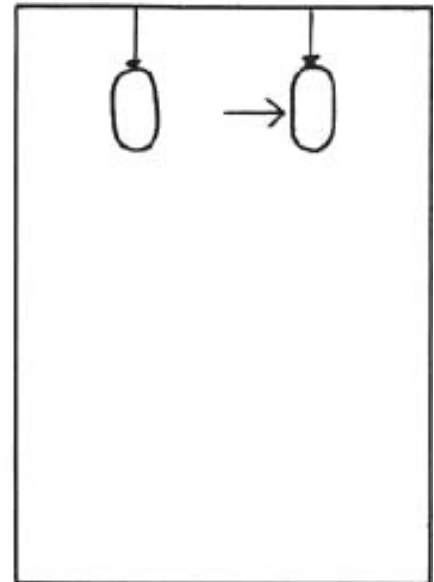

Second bag

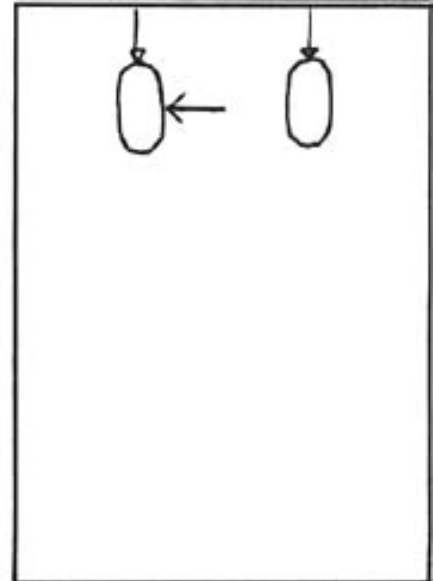

Flying consecutive strike

Second bag

Flying Consecutive Punch

Side View



Back fist

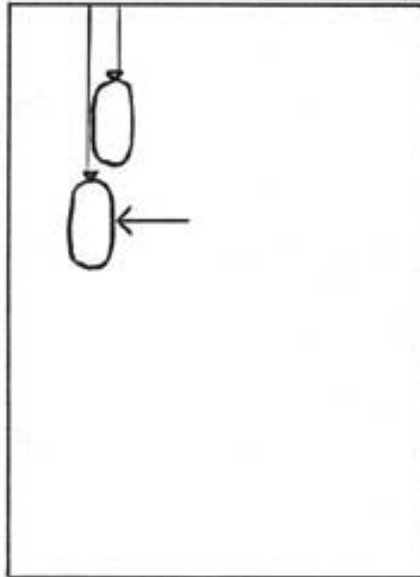

First bag



Second bag



Knife-hand

Flying Combination Hand Attack

First bag

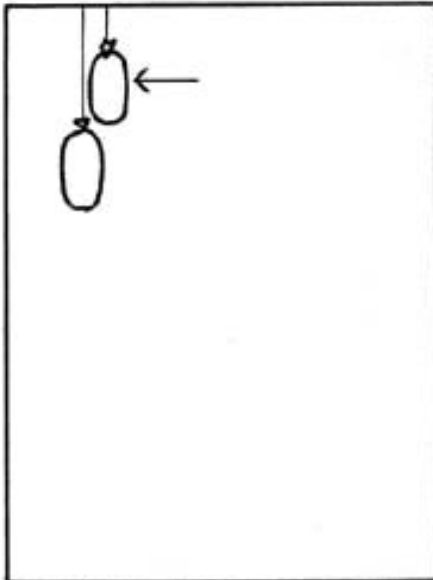

Back fist

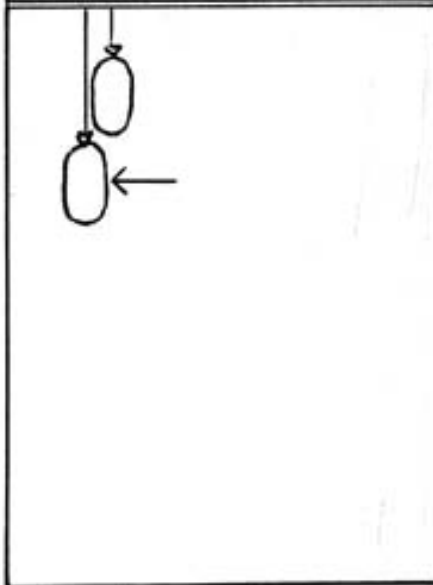

Upset punch

Second bag

- * 1. Flying knife-hand double strike can be executed only vertically and triple strike is not logical.
- 2. Flying back fist strike can be executed both horizontally and vertically however triple strike is not practical.
- 3. Flying combination hand attack can be executed with any combination of tools and methods;
e. g. front punch with back fist side strike, knife-hand inward strike with side punch or double side punch with back fist front strike and so on.

Dodging Punch

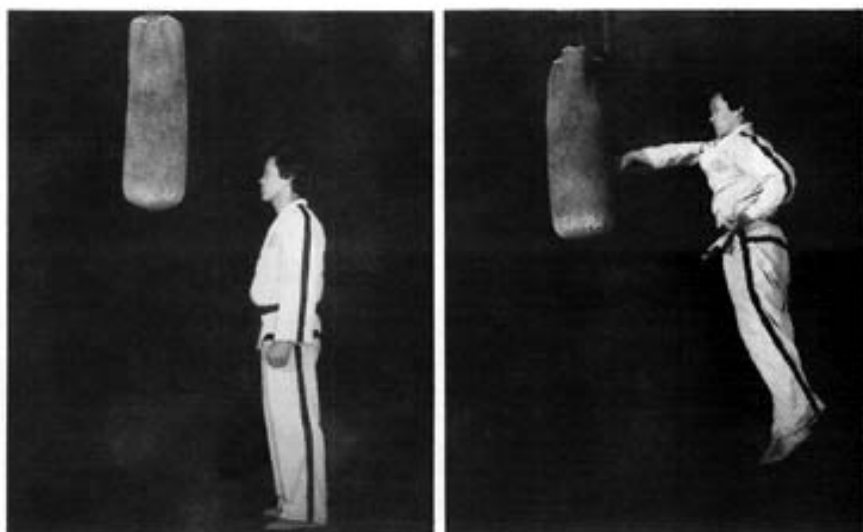

Knife-hand side strike



Dodging strike



Back fist side strike



Air Shield (*Gongi Bangpae*)

This is a useful training aid for kicking without injuries for beginning students.



Focus Shield (*Chotjum Bangpae*)

This particular training aid is used for beginning students to get focus on the proper target.



Forging Pendulum (*Dallyon Gune*)

This training aid is used primarily to practice timing of blocks and kicks after jumping over it. Advanced students may use this aid for toughening the hand and foot parts.

Directions for Making:

1. The pendulum should be made of bamboo or any type of light wood, wound tightly with straw rope. The pendulum should be six feet long and one foot in diameter.
2. Fasten both ends of the pendulum tightly with linen ropes. These ropes will also serve as handles.
3. The handles are linked by hooks which are dropped from the ceiling.





Pushing



Ready to jump



Jumping over

Striking



Front snap kick



Turning kick

Side piercing kick



Vertical kick

Reverse turning kick



Flying side kick



BLOCKING APPARATUS (*Makgi Dae*)

This is an effective device designed to supplement blocking, hooking, pulling, punching, thrusting, and kicking exercises.

The blocking apparatus is especially a valuable device for developing powerful and rapid blocking and counter-attacking techniques. Although this aid can be made in various ways according to individual preference, listed below are some helpful suggestions.

1. The height of the post is 2 meters and 15 centimeters in diameter.
2. The lower portion of the post (1.5 meters) is wound with sponge pad and covered with thin bamboo or straw ropes, and the upper portion with saw ropes.
3. The total length of the bar is 1.8 meters and the distance between the post and the blocking bar 0.8 meter. Two thirds of this bar is wound with straw ropes which serves as the blocking area.
4. A weighing bag made with canvas and filled with sand is attached to the opposite end of the bar, allowing it to move up and down, and to the side when the bar is blocked.
5. The post and the bar are connected with a bolt which acts as a pivot.

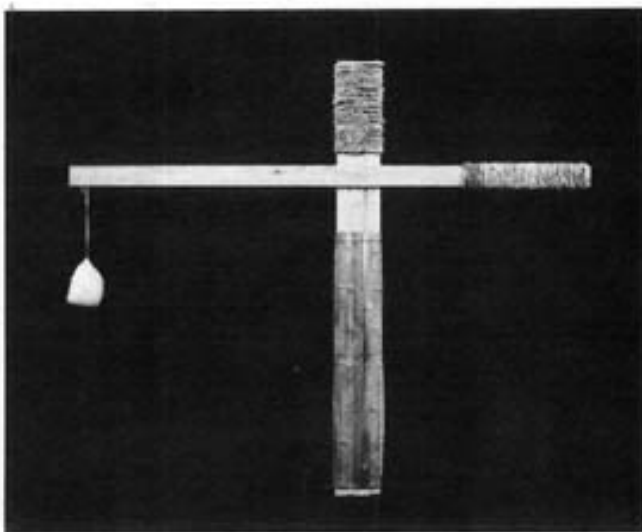

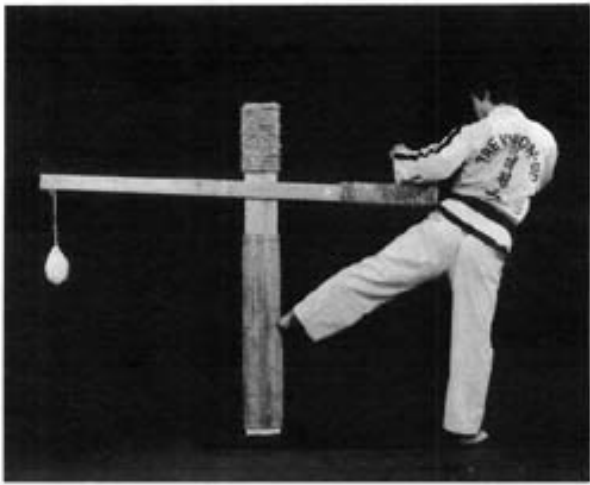

Pressing kick



Front snap kick



Hooking block

Turning kick

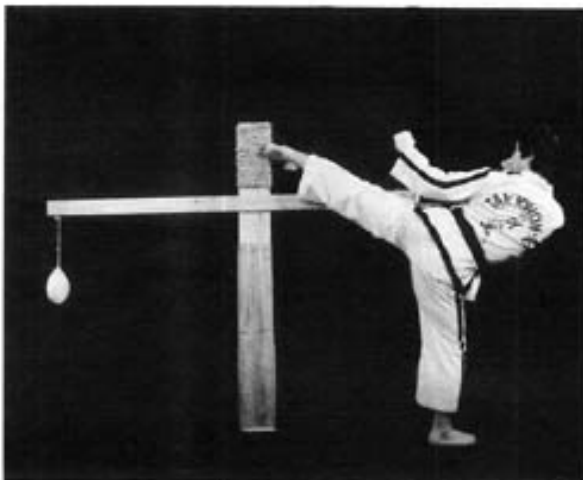

Low punch



Side block



Turning kick

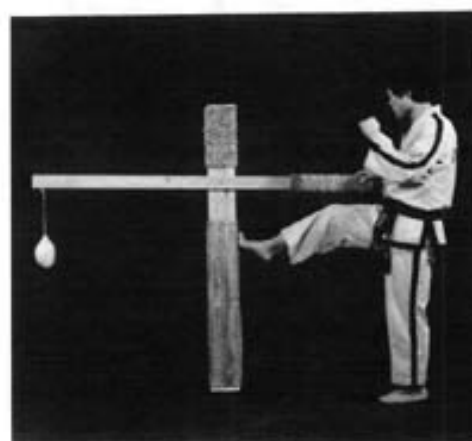

Hooking block

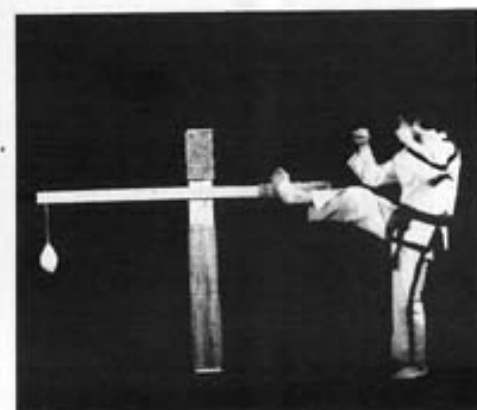



Pullers (*Dallyon Jool*)

This device is used for developing the leg muscles and foot techniques.

1. Affix two pullers to the ceiling four feet apart.
2. Pass a strong rope through the pullers, letting both ends hang to the floor.
3. Each end of the rope is looped to hook the foot.
4. It is recommended that only green belt holders and above use the pullers, since a certain amount of flexibility must already exist in the student's legs. It is very easy for a beginner student to damage leg muscles through improper use.



Twisting kick



Side rising kick



Side piercing kick



Turning kick

Front rising kick



Dumbbells (*Aryong*)

Although this could be considered a helpful training aid for building strength in the chest and arms for a rather weak person, it is not recommended as a regular exercise. Weightlifting may produce an adverse effect on the theory of force, speed, concentration and focus.

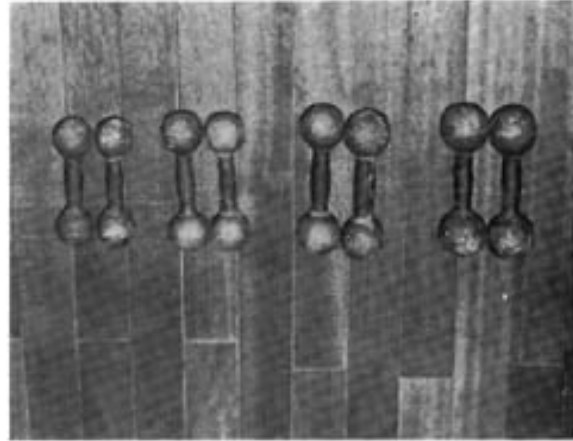

Use of Dumbbells

Lie on a bench and extend both arms to the sides. Bring both arms above the chest in an arc motion.





Wooden Horse (*Mok Ma*)

This is mainly used for flying exercises but can also be used to develop shoulder, chest and arm muscles.



Jump Rope (*Twim Jool*)

This is quite helpful for promoting speed, timing, agility and breath control.



Jar (*Danji*)

The sole purpose of a jar is to develop grip. The size and weight of the jar are optional. It should, however, have a straight mouth.

Use of the Jar:

1. Bend the last joints of the fingers sharply, gripping with the fingertips.
2. As the grip develops, add more and more material such as sand, pebbles to the jar.



Stance Mould (*Sogi Pan*)

This is a simple model of various stances fixed on a flat board. It is useful for learning and reinforcing a correct stance. Actually, it is best to use a mirror as well.

Illustrations:

1. Sitting stance
2. Left walking stance
3. Left L-stance
4. Right X-stance
5. Parallel stance
6. Right rear foot stance
7. Right vertical stance

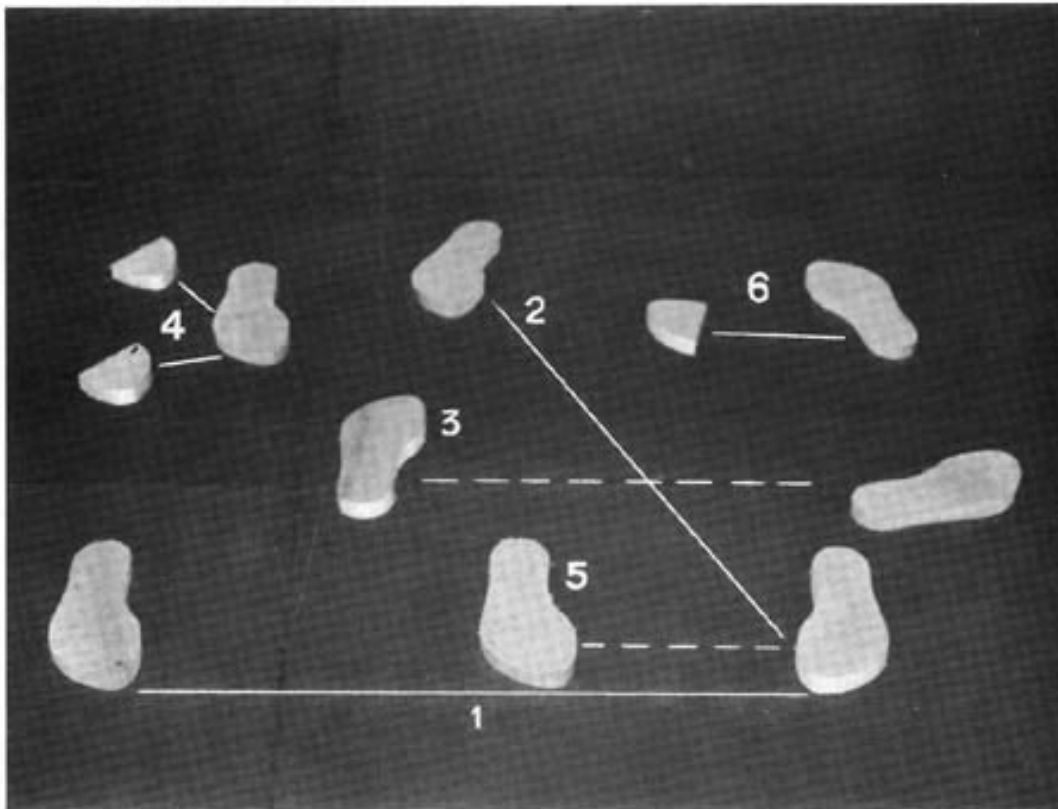

Right rear foot stance

Left walking stance

Left L-stance



Punching Ball (*Dallyon Gong*)

There are two types of punching balls. A long ball is used for kicking and punching exercise; a round one, solely for kicking. This device is particularly good for developing timing in hand and foot techniques.

How to Install

The long ball is usually attached to the wall of the training hall. The bottom of the ball should reach five feet off the ground. Though this can be flexible according to the height of the user.

Punching



Kicking



Long ball

The round ball is fastened between the ceiling and the floor with rubber or elastic thongs. This will make the ball flexible, allowing it to move freely. The center of the ball should reach the student's armpit.

Middle twisting kick



Flying front kick



Round ball

Back piercing kick



Reverse turning kick



Round ball

Finger Toughening Box (*Dallyon Tong*)

The bowl is filled with rice initially, then the contents are gradually replaced with sand. As the fingers are toughened, the sand is replaced with beans.



Foot Raising Bar (*Dari Olligi Dae*)



Mirror (Ko Ui)

A mirror definitely helps the student to observe and improve his techniques as learned from an instructor. Install full length mirrors on walls or columns so that the student can correct mistakes immediately before bad habits set in.

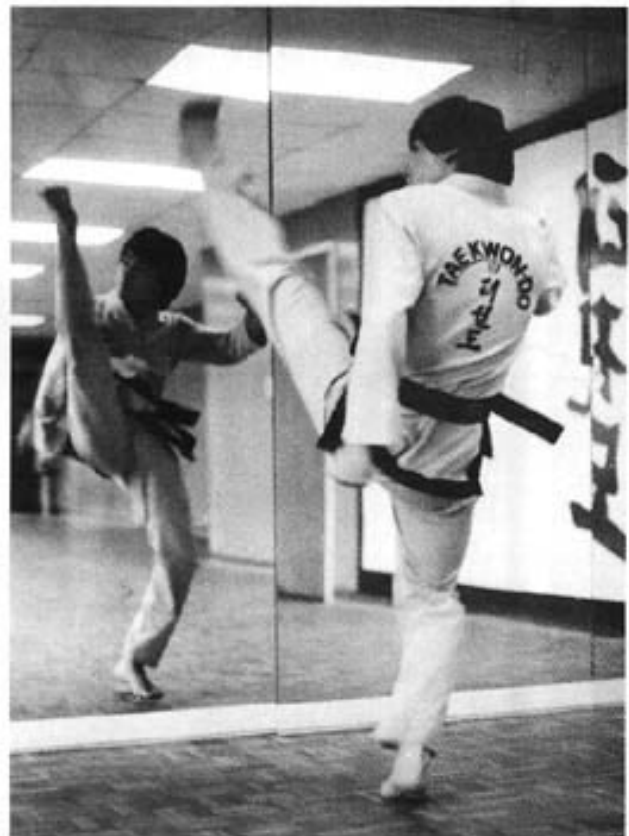

Power Holder (*Gyokpa Dae*)



This device is used to hold boards, bricks or tiles for breaking purposes. The advantage of the holder is that the student can practice alone and eliminate the necessity of one or two fellow students' presence for holding purposes.

The holder consists of a wide and a narrow side. The former holds boards while the latter holds bricks or tiles.

The height varies according to the user, though four feet will usually be the ideal height. The narrow side must be covered with an iron sheet so that the brick is held firmly.



Power Indicator (*Wiryok Gi*)

Before the advent of the power indicator, the only way one was able to judge actual power was through the breaking of boards or bricks. One of the drawbacks of this, however, was that the breaking ability of a student in one part of a country could not be compared to a student's ability in another part of the country. The reason for this is that the consistency of boards and bricks varies from area to area. A student might be able to break four or five pine boards yet not be able to break two pine boards from a neighboring state.

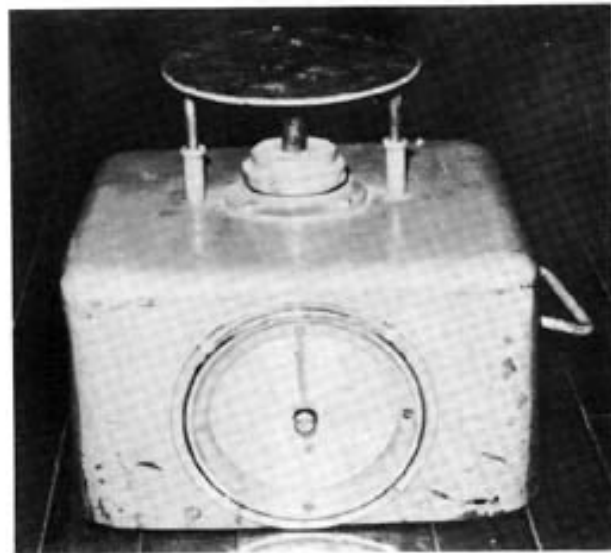

Special Technique Holder (*Tukgi Dae*)

The purpose of this device is to hold the board chiefly for flying high kick, overhead kick and so on, in particular, during competition.



For flying high kick

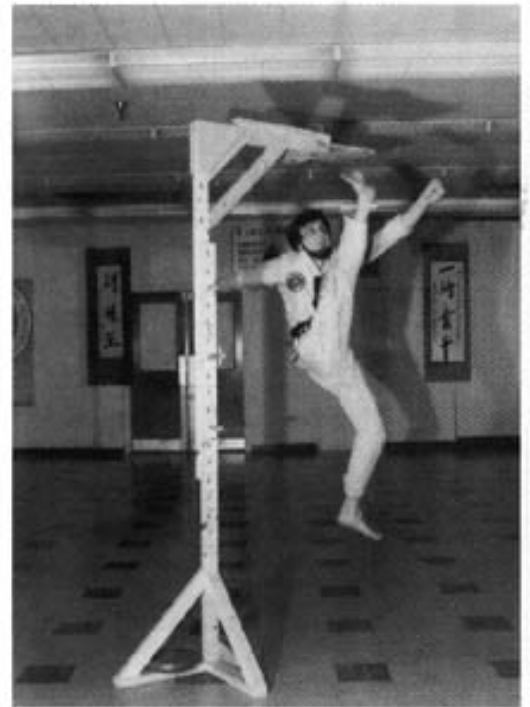

For flying side kick, flying turning kick, flying reverse turning kick, mid-air kick, etc.

Dyna-strike

Dyna-strike serves as fixed and moving targets for all levels of students. It can be punched or kicked harder with full speed as air cushions the blows. It is also an ideal training aid for timing practice when suspended on tree or ceiling. This device was developed by Han Cha Kyo after years of research.

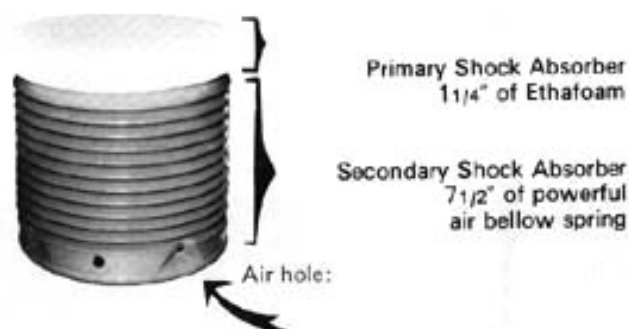

Stretchociser

Principle of the Stretchociser is directly related to the muscle development which affects performance a great deal in Taekwon-Do, particularly for a front, side or back kick. The value of Stretchociser is to prevent injuries during training by promoting flexibility of tendons, joints and ligaments while restoring muscle tone for health as well as good appearance. (Designed by J.C. Kim)



IMPROVISED TRAINING AIDS

As shown in the illustrations, a simple piece of paper or cloth suspended from the ceiling can serve as a very effective training aid to promote accuracy and speed. The object is to move the cloth or paper through the force of the blow without touching it.

Also a tree or a concrete pillar can be used as a training aid for toughening the hand, though this is recommended only to those who have had years of training with the foregoing regular aids since it may result in bone or skin damage.



CALISTHENICS (*Dosoo Dallyon*)

Calisthenics are very good and should be practised by all Taekwon-Do students. They are far more beneficial than weightlifting, are excellent for strengthening muscles and body tone, and can be safely practised by all age groups.

1. Push Ups (*Momtong Bachim*)

This exercise is good for strengthening the forefist or fingertips and developing the chest and arms. Fists should be clenched firmly during the exercise. At first, do the push ups on a soft surface, all the weight resting on the first two knuckles. Gradually, do the exercise on a wooden floor, then a concrete floor or stone.



Fingertips

Forefist



Soft surface

Hard surface



2. Leg Stretching (*Dari Pyogi*)

The purpose of this exercise is to develop and stretch the leg muscles. A student should attempt to raise the leg to the highest apex. There are three positions: standing, squatting, and sitting.

Squatting Position.

Squat on the floor with arms extended forward. Lean the body forward with the knees spread apart. This leg is then stretched sideways until the knee joint touches the ground.



Standing Position

Extend both arms horizontally, kicking the palm with the ball of the foot without bending the body or knees.



INCORRECT
The knee of the stationary leg is bent too much.





Take a close stance, lifting both arms straight upward.



Bend the body downward until the palms reach the floor.



INCORRECT
Knees are bent.



Sit with both feet together, keeping the legs straight and hands placed on the knees.



Bend the body downward until the chest touches the knees while holding the feet with both hands.

Sit with the legs spread out straight, placing the hands around the waist.



Bend the body toward the left until the right ear touches the left knee cap while raising both hands horizontally. The same principle is applied in the opposite direction.



Sit with the soles together and bring them close to the body while keeping the knees on the floor.



Bend the body downward until the forehead reaches the floor while holding the feet with both hands.

Sit with the legs spread out straight, placing both hands on the knees.



Raise the hands upward.



Bend the body downward until the chin touches the floor while stretching both hands forward.



INCORRECT
Knees are not fully stretched.

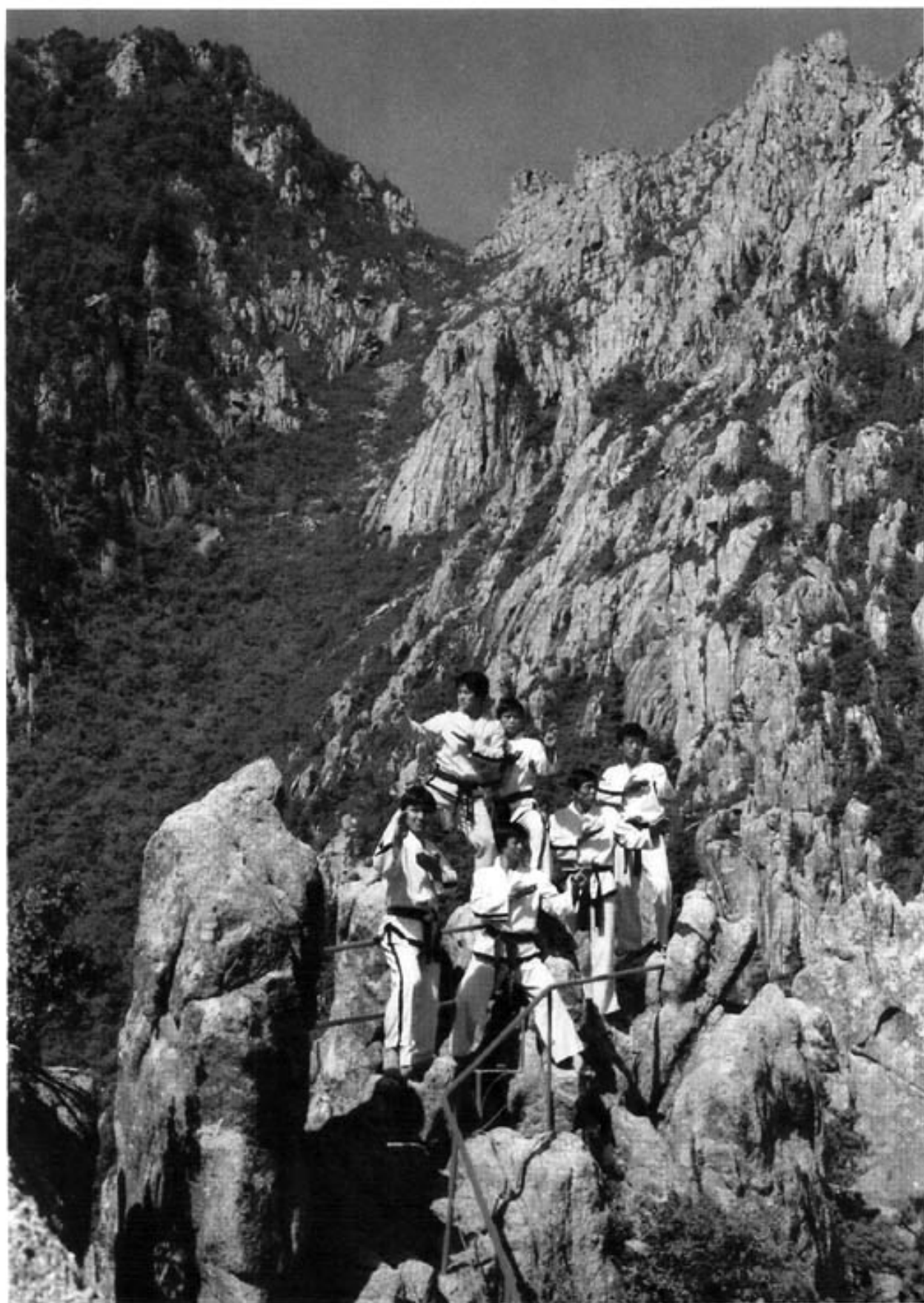

Knocking Exercise

Both forearms and knife-hands can be effectively toughened by knocking against one another. This exercise can be practised alone or with a fellow student. With a companion, there is the added advantage of perfecting focus and timing. This exercise also promotes endurance and tolerance, since each student should attempt to strike as hard as possible and outlast the other. At the moment of knocking, both knife-hands or forearms are crossed.

The term knocking has been applied here to eliminate confusion with forging post striking exercises.



Forearm

Knife-hand





**Toughening of knife-hand alone while on a chair.
The same principle is applicable to the forearm.**

Knife-hand with a companion.



Forearm with a companion.

Forearm

The methods used in forearm knocking are exactly the same as knife-hand motions, with one exception; the hand is brought down to the level of the abdomen at the moment of knocking, and the outer and inner forearms are knocked against each other alternately.





SYNOPSIS

The Encyclopedia of Taekwon-Do consists of 15 volumes. The contents of each volume is listed below:

- VOLUME I:**
- 1) Origin and Development of Martial Arts
 - 2) History of Taekwon-Do
 - 3) Moral Culture
 - 4) Philosophy
 - 5) Training Schedule
 - 6) Cycle and Composition of Taekwon-Do
 - 7) Demonstration
 - A) Model Sparring
 - B) Pre-arranged Free Sparring
 - C) Sample of Self-defence Techniques
 - 8) About the Author
 - 9) Group photos
- VOLUME II:**
- 1) Theory of Power
 - 2) Attacking and Blocking Tools
 - 3) Vital Sports
 - 4) Training
 - A) Training Hall
 - B) Conduct in Do Jang
 - C) Training Equipment
 - D) Practice Suits
 - 5) Stances
 - 6) Training Aids
- VOLUME III:** Hand Techniques
- VOLUME IV:** Foot Techniques
- VOLUME V:** Sparring
- VOLUME VI:** Fundamental Exercises (A)
- VOLUME VII:** Fundamental Exercises (B)

- VOLUME VIII:**
- 1) Four-Direction Punch
 - 2) Four-Direction Block
 - 3) Pattern Chon-Ji
 - 4) Pattern Dan-Gun
 - 5) Pattern Do-San
- VOLUME IX:**
- 1) Pattern Won-Hyo
 - 2) Pattern Yul-Guk
 - 3) Pattern Joong-Gun
- VOLUME X:**
- 1) Pattern Toi-Gae
 - 2) Four-Direction Thrust
 - 3) Pattern Hwa-Rang
 - 4) Pattern Choong-Moo
- VOLUME XI:**
- 1) Pattern Gwang-Gae
 - 2) Pattern Po-Eun
 - 3) Pattern Ge-Baek
- VOLUME XII:**
- 1) Pattern Eui-Am
 - 2) Pattern Choong-Jang
 - 3) Pattern Juche
- VOLUME XIII:**
- 1) Pattern Sam-Il
 - 2) Pattern Yoo-Sin
 - 3) Pattern Choi-Yong
- VOLUME XIV:**
- 1) Pattern Yon-Gae
 - 2) Pattern Ui-Ji
 - 3) Pattern Moon-Moo
- VOLUME XV:**
- 1) Pattern So-San
 - 2) Pattern Se-Jong
 - 3) Pattern Tong-Il

INDEX

A

air shield (gonggi bangpae) 264
angle fingertip (homi sonkut) 68
arc-hand (bandal son) 70
attacking and blocking tolls 49-84
attention stance (charyot sogi) 160

B

back fist (dung joomuk) 61
back hand (sondung) 70
back heel (dwichook) 80
back sole (dwitkumchi) 79
back tibia (dwit gyonggol) 84
ball of the foot (apkumchi) 77
base of knife-hand (sonkal batang) 74
bear hand (gomson) 74
bending ready stance (guburyo junbi sogi) 165
bending stance (guburyo sogi) 155
blocking apparatus (makgi dae) 268
blocking tools (makgi boowi) 52-84
bow wrist (sonmokdung) 75
breath control (hohup jojul) 31

C

calisthenics (dosoo dallyon) 285
close ready stance (moajunbi sogi) 163
close stance (moa sogi) 135
concentration (jip joong) 20
conduct in do jang 172
crouched stance (oguryo sogi) 152
courtesy (ye ui) 8,9,10

D

diagonal stance (sasun sogi) 151
double fingertip (doo sonkarak) 69
dumbbells (aryong) 273
dynamic stability (dongtchuk anjong) 28
dyna-strike 283

E

equilibrium (kyun hyung) 24-30
explanation of tenets 10-12

F

finger belly (songarak badak) 75
finger pincers (jipge son) 74
finger toughening box (dallyon tong) 278
fixed stance (gojung sogi) 146
focus shield (chotjum bangpae) 264
foot parts (ha bansin) 76-82
forearm (palmok) 71
 back forearm (dungpalmok)
 inner forearm (anpalmok)
 outer forearm (bakatpalmok)
 under forearm (mitpalmok)
forefinger (han sonkarak) 69
foot-raising bar (dari olligi dae) 278
footsword (balkal) 78
forefist (ap joomuk) 53-59
fore-knuckle fist (inji joomuk) 63
forging bag (dallyo bag) 241
 how to use 243
forging pendulum (dallyon gune) 265-267
forging post (dallyo joo) 186
 how to use 194

G

H

hand parts (sang bansin) 53-75
head (mori) 83
 forehead (ima) 83
 occiput (hudoo) 83

I

improvised training aids 284
indomitable spirit (baekjul bool-gool) 8,9,12
instep (baldung) 81

inner ankle joint (anbalmok gwanjol) 83
inner tibia (angyong gol) 84
integrity (yom chi) 8,9,11

————— J —————

jar (danji) 275
jump rope (twim jool) 275

————— K —————

knee (moorup) 79
knife-hand (sonkal) 64
knuckle fist (sonkarak joomuk) 63

————— L —————

1-stance (niunja sogi) 141-145
long fist (ghin joomuk) 62
low stance (nacho sogi) 159

————— M —————

mass (zilyang) 35-37
miscellaneous parts (gita boowi) 82-84
middle knuckle fist (jungji joomuk) 63
mirror (koul) 279

————— O —————

one-leg stance (waebal sogi) 154
open fist (pyun joomuk) 62
open ready stance (palja junbi sogi) 162
outer ankle joint (bakat balmok gwanjol) 83
outer tibia (bakat kyonggol) 84

————— P —————

palm (sonbadak) 62
parallel ready stance (narani junbi sogi) 161
parallel stance (narani sogi) 136
perseverance (innae) 8,9,11
power holder (gyokpa dae) 280
power indicator (wiryok gi) 281
practise suit (dobok) 176-185
 blet (ti) 180,181

 how to fold the do bok 182, 183
 how to tie the belt 184,185
press finger (giap) 74
pullers (dallyon jool) 272
punching ball (dallyon gong) 277

————— R —————

reaction force (bandong ryok) 15-19
ready stance (junbi sogi) 160
 attention stance 160
 close ready stance 163,164
 open ready stance 162
 bending ready stance 165
 walking ready stance 164
rear foot stance (twitbal sogi) 157,158
relation of attacking tool and vital spots
 100-129
reverse footsword (balkal dung) 82
reverse knife-hand (sonkaldung) 68

————— S —————

section of the body (mom dungboon) 90
self-control (guk gi) 8,9,12
shin (jong kwaeng-i) 84
shoulder (eukke) 83
side instep (yop baldung) 81
side sole (yop balbadak) 82
sitting stance (annun sogi) 148-150
special technique holder (tukgi dae) 272
speed (sokdo) 38-41
speed and reflex (sokdo wa banung) 42-47
stance (sogi) 135-167
 bending stance 155
 close stance 135
 crouched stance 152
 diagonal stance 151
 fixet stance 146-147
 l-stance 141-145
 low stance 159
 one-leg stance 154
 open stance 137
 parallel stance 136
 rear foot stance 157,158
 sitting stance 148-150

vertical stance 156
walking stance 138-140
stance mould (sogi pan) 276
static stability (jungtchuk anjong) 28
straight fingertip (sun sonkut) 68
stretchoiser 283

————— **T** —————

table of contents 5
Taekwon-Do jungshin 8
theory of power 14
thumb (umji) 69
thumb knuckle fist (umji joomuk) 63
thumb ridge (umji batang) 75
tibia (kyonggol) 84
toe edge (balgarak nal) 84
toes (balkut) 82
training (sooryon) 169
training aids (dallyon goo) 186
training equipment (sooryon jangbi) 174
training hall (do jang) 171-173

————— **U**

upset fingertip (dwijibun sonkut) 68

————— **V** —————

vital spots (kupso) 88
vertical stance (soojik sogi) 156

————— **W** —————

walking ready stance (gunnun junbi
sogi) 164
walking stance (gunnun sogi) 138-140
wooden horse (mok ma) 274

————— **X** —————

x-stance (kyocha sogi) 153

